

C.S. ERGONOMICS

“We won’t relax ‘til our customers can”



THE COMFORT SHOP

**2008
Edition One**

Welcome

to our **C.S. Ergonomics catalogue.**

Back care essentials for the workplace.

Since 1989, The Comfort Shop Ltd., has retailed back-care chairs, special desks and a host of other ergonomically-designed products for the office.

Over the years, we have tried and tested many items. All the goods in this catalogue have met our high standards, proved themselves useful on many occasions and easily passed the test of time.

Health care professionals, personnel managers employers and of course, back pain sufferers are becoming increasingly aware of how important it is to be comfortable at work.

Although it is now widely accepted comfortable workers in a decent workplace will be happy and productive, it is still surprising how often an ergonomically favourable work environment is neglected or overlooked.

Staff in offices, call centres, factories, laboratories, banks, shops, design studios etc., all deserve well-designed chairs and thoughtfully set-out work areas. So do students, teachers and people driving vehicles of all kinds.

Perhaps you are a parent. If so, what sort of chair do you let your child sit in for hours on end for doing homework or playing on a computer? Would you sit in it? If you are an employer, the same question could well apply.

How we can help:-

A major part of our business is special chairs and other useful products for people experiencing discomfort at work, at home and travelling.

We are a helpful, flexible firm and can respond swiftly to your needs.

We like to deliver our goods personally, so customers gain the most from their purchase.

We can occasionally lend chairs to help customers make a final choice.

We can call upon trained ergonomists, physiotherapists and occupational therapists when the need arises.

And finally, since we started all those years ago, our motto remains unchanged...

"We won't relax 'til our customers can"

CONTENTS

Back 'Stats' ... Back Pain how it affects us and what it costs ...	Page 4
Seating in your workplace—Useful tips	Page 5
How to decide on the right chair	Page 6-7
The Comfort U-100.... (£99 inv VAT	Page 8
The Comfort U-200.... (£198 inc VAT).....	Page 9
The Comfort U-250.... (£250 inc VAT).....	Page 10
The Comfort U-300.... (£298 inc VAT).....	Page 11
The Comfort U-390.... (£388 inc VAT).....	Page 12
The Comfort U-400.... (£398 inc VAT).....	Page 13
The Comfort U-490.... (£488 inc VAT).....	Page 14
The Comfort U-500.... (£498 inc VAT).....	Page 15
The Comfort U-Nique (£438 inc VAT).....	Page 16
Heavy-duty (Bariatric) ... (248Kg, 39-stone chairs).....	Page 17-22
Adapt 600... (standard-size mid-price Knee-tilt chairs).....	Page 23
Adapt 600... (smaller-size mid-price Knee-tilt chairs).....	Page 24
Adapt 500... (standard Asynchronous mid-priced chairs)....	Page 25
Adapt 700... (standard Synchronous mid-priced chair).....	Page 26
Adapt chairs (movement-locks and split-seats).....	Page 27
Adapt chair...(optional extras). & new portable backrest....	Page 28
RH Logic 300—400 chairs.....	Page 29-32
RH Logic 3 and 4 chairs	Page 33
RH Activ chairs and Extend chairs	Page 34-35
RH chair optional extras	Page 36
Rabami 800 and 700 chairs	Page 37-38
Albion Spynamics chair	Page 39
Grahl Duo-back chair	Page 40
Advance Seating Designs chairs	Page 41
Comfort Extras for office chairs	Page 42
Salli, Hag Capisco, RH and ASD saddle & support stools ..	Page 43-47
Industrial Task Stools and chairs	Page 48
Desk and Desktop Accessories—Useful tips	Page 49
Desks - electric height-adjustable	Page 50-52
Desks - crank height-adjustable	Page 53-54
Desks - basic fixed-height	Page 55-57
Desk extenders, Monitor arms	Page 58
Posture blocks, screen raisers and foot rests	Page 59
Writing slopes, document holders, laptop stands & kits.....	Page 60-61
Keyboards and Mice.....	Page 62-63
Wrist rests and Metal Corner Desk Extender	Page 64
Backrests and portable back supports	Page 65-66
Hip seats, chair mats and kneeler stools	Page 67
Terms of Business and mail-order form	Page 68-69

Back 'Stats'

Back pain affects most of us at some stage of our lives.

About 80% of us will experience back pain lasting more than a day.

Almost half of British adults will report low back pain lasting at least 24 hours at some time during the year.

Almost 10 million women have back pain each year.

Studies show between 40%-60% of pregnant women get back pain.

Men's back pain is often the result of injury, while women's is part of their everyday lives.

People who experience back pain as a child or teenager are more likely to experience back pain as an adult.



What Back pain costs The NHS.

Back pain costs the NHS and community care services more than £1 billion each year. This includes:

£141 million each year for GP consultations (At least 5 million adults consult their GPs annually about back pain).

£151 million for NHS physiotherapy.

£512 million for hospital care (in-patient, out-patient and emergency).

A further £565 million are spent on private services.

Ten percent of those complaining of back pain visited a complementary practitioner, such as an osteopath, chiropractor or acupuncturist.

Nurses are particularly prone to back pain. 80,000 nurses injure their backs each year and 3,600 are invalided out as a result.

Back pain affects Britain's Economy.

Back pain is the nation's leading cause of disability, with 1.1 million people disabled by it.

On any one day, about 1% of the working-age population are on sickness absence due to a back problem.

Nearly 5 million working days were lost through bad backs in 2003/4. On average, each sufferer took about 20 days off in that period.

HSE (Health and Safety Executive) estimates show work-related musculoskeletal disorders cost employers between £590 -£624 million per year.

One in eight (13%) of unemployed people say back pain is the reason they are not working. At any one time, 430,000 people in the UK are receiving Social Security payments primarily for back pain.

The total cost of back pain corresponds to between 1% and 2% of Britain's Gross National Product (GNP).

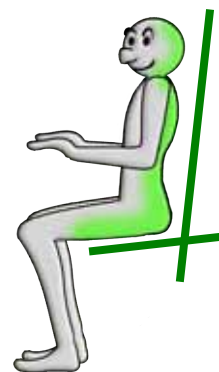

What can lead to back pain in the workplace?

Sitting at a workstation for a long period of time if the workstation is not correctly arranged or adjusted to suit the person, e.g. working with computers;

Driving long distances or driving over rough ground (people who drive over 25,000 miles a year averaged just over 22 days a year off work with bad backs, compared with just over 3 days a year for low-mileage drivers);

Repetitive tasks, such as manual packing of goods;

Awkward manual handling such as delivery work;

Heavy manual labour.

Seating in your workplace—*Useful tips*

In a nutshell, an office chair should **allow** the user to find the most comfortable position. The word **allow** is emphasised because so many chairs are simply not adjustable *enough*. When choosing a chair, look for:

- ◆ Seat height adjustment, which permits a wide range of seat height settings
- ◆ Seat tilt adjustment, where the seat can be angled forward, set level or tilted backwards.
- ◆ Back height adjustment, easily altered by the user, preferably while sat in the chair.
- ◆ Back angle adjustment, where the back's 'angle of attack' can be altered to suit a task.
- ◆ Arm height adjustment, to let the user select a height which supports their arm weight.
- ◆ Arm width adjustment, offering support while the user's arms are kept close to their sides.
- ◆ Appropriate support for the lumbar (lower) and thoracic (upper) part of the back.
- ◆ A seat cushion which prevents excess pressure under the thighs and behind the knees.

Chairs do not need all these features; however, most if not all, can be found on many models we've selected for this catalogue.

Good posture can be easily achieved in a chair and desk are well set up for the task in hand.

- ⇒ When settling down to work, try to:
- ⇒ Leave plenty of space for your legs under the desk.
- ⇒ Make sure your chair armrests do not collide with the desk or prevent you sitting as near as you want to your workstation.
- ⇒ Keep your forearms approximately horizontal. The right kind of armrests should help you achieve this.
- ⇒ Try to avoid undue extension, flexion or awkward deviation of the wrists.
- ⇒ Set your computer screen height to prevent awkward neck positions. Looking straight at a screen is much better than peering up, down or sideways at it for hours on end.
- ⇒ Leave ample room in front of the keyboard, so arms and wrists can be well rested during pauses.
- ⇒ Consider using a footrest, if you cannot rest your feet on the floor once the chair and desk heights are in set at correct and comfortable heights.

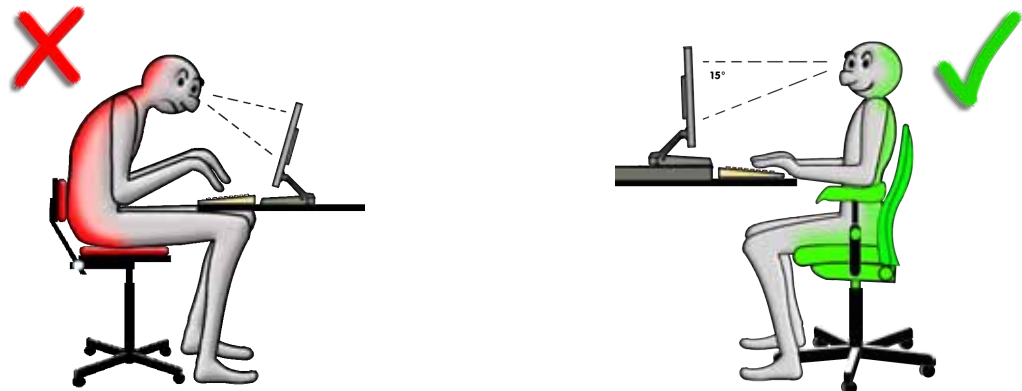

Useful Websites:

BackCare: Telephone 0845 130 2704. Website www.backpain.org. email info@backcare.org.uk

The Health & Safety Executive (HSE): Helpline 0845 345 0055. Website www.hsebooks.co.uk

Useful Publications:

Health & Safety (Display Screen Equipment) Regulations 1992, amended 2002. HSE Books 2003 ISBN 0 7176 2582 6.

The law on VDUs: An easy guide to Health & Safety (Display Screen Equipment) Regulations 1992 (amended 2002). HSG90 HSE Books 2003 ISBN 0 7176 2602 4.

Understanding Ergonomics at Work. HSE Books INDG90.

Working with VDUs. HSE Books INDG36.

For a wide range of back care books and all kinds of self-help and back pain management advice, visit the [BackCare](http://www.backcare.org.uk) site listed above.

Decisions, decisions, decisions.....

Just ask yourself 'What do I do at work'?.....

Am I a person who holds conferences in my office or via the web? Do I read or write a lot of reports? Do I work intensely on my computer one minute, then sit back to check my work on-screen the next? Do I slouch while on the telephone? Do I slide down in my seat? Am I constantly swivelling on my chair and reaching for papers or discs etc., from drawers or nearby storage cabinets or shelves?

Does my work mainly comprise desktop-based tasks, such as reading in one position for long periods, writing reports or essays, copy typing or repetitive data entry? Do I tend to work for long and sometimes intensive periods without moving around on my chair very much?

Am I constantly leaning to-and-fro over my desk? Am I always picking up the phone and leaning forward to take notes? Do I work at a counter, where I serve or interview people all day long? Would I be less tense if my back was able to remain in motion, but stay in contact with my chair while I worked?

Am I really very uncomfortable at work and worried my problems will begin to affect my performance, or even prevent me from working at all some time in the future? Should I start looking for a very special type of chair?

Have I given up trying to find a chair which will fit me properly? What types of chair are there for people who are really much taller or smaller than average. Can I get a chair or desk which people of very different heights can use, or even take turns to share?

What kinds of chair can be used by different people every hour of the day and night? For instance people working three shifts in a call centres or an air traffic control centre. I and my colleagues never use the same chair twice it seems and we can never find our 'favourite' chair.

I am a big person and I don't feel very secure on the chairs used by everyone else in the office. I need a very heavy duty chair, but I don't really want it to stand out from all the rest.

I spend a great deal of time working at home. I sit on a dining room chair when I use my laptop on the table. Sometimes I sit on the sofa and to peck away awkwardly at my laptop on my knees! I need a decent office chair indoors, but it needs to fit in a small working space.

MORE DETAILS PLEASE: If you want to know more *JUST ASK!*

We can easily send your extra product information. It can be posted or emailed or we can send you links to manufacturers' websites.



Chair performance at a glance....

.....And 'what kind of chair will suit me best'?

A floating chair is often good for dynamic and active sitting; when your job involves plenty of leaning forwards, backwards and swivelling between tasks.



**FLOATING
CHAIR**

A multi-set chair allows separate, quick and easy adjustment of seat and backrest angles, from within the chair. Sometimes called 'independent action' chairs.



**MULTI-SET
CHAIR**

A synchro chair can be set to apply gentle and constant pressure to the user's back as they move forward and backwards during tasks.



**SYNCHRO
CHAIR**

Some chairs have been designed from the outset with unusual or unique technical features to help users sit with a good posture.



**POSTURE
CHAIR**

Custom-made chairs can be built for people with special comfort needs. Such chairs may be very big or quite tiny. They may have control levers in special places or upholstery has been altered in some way. Some can be fitted with movement locks or in-built massage systems.



**CUSTOMISED
CHAIR**

Chairs used 24 hours a day, seven days a week by different people 'hot-chairing' in three different shifts. A 24-7 chair must be very strong and easy to adjust to suit all shapes and sizes. You may require contract fabrics too.



**24-7
CHAIR**

(248Kg). Extra-strong heavy-duty chairs are easily available nowadays. Many off-the-peg models in this catalogue can support people weighing up to 23-stone (146Kg). Our strongest chairs can support 273 Kg (42-stone)



**EXTRA
STRONG**

Office chairs, for people working at home, are compact, easily adjustable and sometimes have a slightly smaller star base. Ideally the chair can be adjusted to suit adults of different sizes, as well as young people (doing homework or using a computer). They should have adjustable seat depth.



**Home
Working**

CAN YOU SEND ME A CD ROM?

Moving images, showing some of our chairs 'in action' can be sent to you or seen on the internet. JUST ASK !



The Comfort 'U-Range'

A family of excellent back-care chairs which all cost less than £500 including VAT.

These carefully-chosen chairs have features and benefits previously unavailable, until now, for such a low price.



The Comfort U-100

£84.26 + VAT
(£99)



The Comfort U-100 High Back Chair with arms

One lever operates the pre-determined free-flow **synchro** action for seat and back. Release the lever, move your body until the seat and back are in the position you want, then lock them into position again. Repeat every time a fresh seating position is required. Easy.

Dimensions:

Seat Height	45-58 cm
Seat Width	46 cm
Seat Depth	46 cm
Overall height	116 cm

Cost-effective EC compliant operator and workstation seating. Five-year structural guarantee, with two-year guarantee for fabric and moving parts, based on being used in normal eight-hour day working conditions.

For chairs without arms deduct £20 + VAT
£23.50 inc VAT



The Comfort U-120

£101.28 + VAT
(£119)



The Comfort U-120 Manager Chair with arms

The Manager Chair is more generously proportioned than the Comfort U-100. It has **independent** seat and back angle adjustment for maximum comfort. Both chairs have five-position height-adjustable arms.

Dimensions:

Seat Height	44-54 cm
Seat Width	50 cm
Seat Depth	48 cm
Overall height	120 cm

C.S.ERGONOMICS

17, Alexandria Drive,
St Annes, Lancashire, FY8 1JF.
www.the-comfort-shop.co.uk

(01253) 724902

THE COMFORT SHOP

The Comfort 'U-Range'

A family of excellent back-care chairs which all cost less than £500 including VAT.

These carefully-chosen chairs have features and benefits previously unavailable, until now, for such a low price.



The Comfort U-200

£168.51 + VAT
(£198)



The Comfort U-200

- ◆ A modern Tri-curved backrest.
- ◆ Generous double-curved seat
- ◆ Inflatable lumbar support
- ◆ Sliding seat depth adjustment (5cm).
- ◆ Height & depth-adjustable arms.
- ◆ Heavy-duty tension controls for **independent** seat & back actions..
- ◆ Top weight limit 115Kg (18 stone).

Ergonomic seating for office and home working.

Sliding seat depth and adjustable-height back allows adults and children to easily share the same chair. Excellent chairs for home study and computer games.



Option PB £37 + VAT
An extra (£43.48)

Weight limit upgrade

Increase the top weight limit of this chair to 150 Kg (24 stone) with a metal polished base. Just select **option PB** when ordering

Dimensions:

Seat depth; 46-51 cm
Seat width; 49 cm
Overall width with arms; 65 cm
Back height top-bottom; 52cm
Back width (widest part); 47 cm
Back height range; 6 cm
Seat height range (black base); 46-52 cm
Seat height range (polished base); 46-52 cm

All models carry a full five year guarantee, two years for 24 hour use, subject to normal usage

Nobody weighing more than 100 Kg (approx 16-stone) should use a gas lift chair unless it has been specially designed to accommodate heavier people safely. (Seating at work HSE Books HSG57)

C.S.ERGONOMICS

17, Alexandria Drive,
St Annes, Lancashire, FY8 1JF.
www.the-comfort-shop.co.uk

(01253) 724902

THE COMFORT SHOP

The Comfort 'U-Range'

A family of excellent back-care chairs which all cost less than £500 including VAT.

These carefully-chosen chairs have features and benefits previously unavailable, until now, for such a low price.



Inflatable lumbar support

◆ Double-curved U-250 backrest
Thoracic support & Lumbar support

The Comfort U-250

£211.06 + VAT
(£248)



The Comfort U-250

- ◆ **Synchro'** or **Independent** actions.
- ◆ Double-curved backrest
- ◆ Height-adjustable backrest
- ◆ Large double-curved waterfall seat
- ◆ Adjustable tension to suit bodyweight
- ◆ Sliding seat depth
- ◆ Inflatable lumbar support
- ◆ Height-adjustable arms
- ◆ Top weight limit 115Kg (18 stone).

Ergonomic seating for office and home working.

Sliding seat depth and adjustable-height back allows adults and children to easily share the same chair. Excellent chairs for home study and computer games.



Option AB (pyramid base)

£37 + VAT
(£43.48)

Weight limit upgrade

Increase the top weight limit of this chair to 150 Kg (24 stone) with a metal polished base. Just select **option PB** when ordering



Bodyweight tension adjustment

Dimensions:

Seat depth; 47-52 cm
Seat width; 49 cm
Overall width with arms; 65 cm
Back height top-bottom; 53 cm
Back width (widest part); 44 cm
Back height range; 8 cm
Seat height range (black base); 41-53 cm
Seat height range (polished base); 41-53 cm

All models carry a full five year guarantee, two years for 24 hour use, subject to normal usage

Nobody weighing more than 100 Kg (approx 16-stone) should use a gas lift chair unless it has been specially designed to accommodate heavier people safely. (Seating at work HSE Books HSG57)

The Comfort 'U-Range'

A family of excellent back-care chairs which all cost less than £500 including VAT.

These carefully-chosen chairs have features and benefits previously unavailable, until now, for such a low price.



The Comfort U-300

£253.62 + VAT
(£298)



The Comfort U-300

- ◆ A modern, contoured backrest.
- ◆ Heavy-duty tension controls for **independent** seat & back actions.
- ◆ Height, depth and width-adjustable arms.
- ◆ A generous double-curved seat.
- ◆ Sliding seat depth adjustment (5cm).
- ◆ Inflatable lumbar support
- ◆ Top weight limit of 115 Kg (18-stone).

Fold-away height-adjustable arms

Available as a special option at no extra cost. Select **option AF** when ordering.



Weight limit upgrade

Increase the top weight limit of this chair to 150 Kg (24 stone) with a metal polished base. Just select **option PB** when ordering

Option PB £37 + VAT
An extra (£43.48)



A performance seat 'memory' foam

seat cushion available as a special option at no extra cost. Select **option PF** when ordering

Dimensions:

Seat depth; 47-52 cm
Seat width; 49 cm
Overall width with arms; 65 cm
Back height top-bottom; 56 cm
Back width (widest part); 47 cm
Back height range; 7 cm
Seat height range (black base); 48-58 cm
Seat height range (polished base); 48-58 cm
Seat angle range; -8 to +5 degrees

All models carry a full five year guarantee, two years for 24 hour use, subject to normal usage

Nobody weighing more than 100 Kg (approx 16-stone) should use a gas lift chair unless it has been specially designed to accommodate heavier people safely. (Seating at work HSE Books HSG57)

C.S.ERGONOMICS

17, Alexandria Drive,
St Annes, Lancashire, FY8 1JF.
www.the-comfort-shop.co.uk

(01253) 724902

THE COMFORT SHOP

The Comfort 'U-Range'

A family of excellent back-care chairs which all cost less than £500 including VAT.

These carefully-chosen chairs have features and benefits previously unavailable, until now, for such a low price.



The Comfort U-390

£330.21 + VAT
(£388)



The Comfort U-390

- ◆ A supremely effective and comfortable Tri-curved spine-shaped adjustable-backrest.
- ◆ Smart upholstered back
- ◆ Inflatable lumbar support
- ◆ Height, depth and width-adjustable arms.
- ◆ A generous double-curved seat.
- ◆ Sliding seat depth adjustment (5cm).
- ◆ Heavy-duty tension controls for **independent** seat & back actions.
- ◆ Smart polished base with big easy-roll castors.

Fold-away height-adjustable arms

Available as a special option at no extra cost. Select **option AF** when ordering.



A performance seat 'memory' foam

seat cushion available as a special option at no extra cost. Select **option PF** when ordering

All models carry a full five year guarantee, two years for 24 hour use, subject to normal usage

Dimensions:

Seat depth; 47-52 cm

Seat width; 49 cm

Overall width with arms; 65 cm

Back height top-bottom; 59 cm

Back width (widest part); 49 cm

Back height range; 8 cm

Seat height range (polished base); 46-56 cm

Seat angle range; -8 to+5 degrees

Nobody weighing more than 100 Kg (approx 16-stone) should use a gas lift chair unless it has been specially designed to accommodate heavier people safely. (Seating at work HSE Books HSG57)

C.S.ERGONOMICS

17, Alexandria Drive,
St Annes, Lancashire, FY8 1JF.
www.the-comfort-shop.co.uk

(01253) 724902

THE COMFORT SHOP



The Comfort 'U-Range'

A family of excellent back-care chairs which all cost less than £500 including VAT.

These carefully-chosen chairs have features and benefits previously unavailable, until now, for such a low price.

The Comfort U-400
 £338.72 + VAT
 (£398)



The Comfort U- 400

This chair contains a unique combination of back-care features never found on one chair before.

- ◆ A modern, contoured backrest.
- ◆ Smart upholstered back
- ◆ A smooth, weight-adjustable **synchro'** action.
- ◆ A **unique seat with a hinged front edge** to alleviate pressure behind the thighs.
- ◆ Inflatable lumbar support
- ◆ Height & depth-adjustable arms.
- ◆ Pivoted height & depth adjustable neck rest
- ◆ A generous contoured seat.
- ◆ Extra-long sliding seat depth adjustment (8cm).
- ◆ Smart chrome base with big easy-roll castors.
- ◆ Top weight limit of 150 Kg (24-stone).



Fold-away height-adjustable arms

Available as a special option at no extra cost.
 Select **option AF** when ordering.

Dimensions:

Seat depth; 46-54 cm
 Seat width; 49 cm
 Overall width with arms; 61.5 cm
 Back height top-bottom; 55 cm
 Back height range; 6 cm
 Back width (widest part); 47 cm
 Seat height range (chrome base); 44-57 cm

All models carry a full five year guarantee, two years for 24 hour use, subject to normal usage

Nobody weighing more than 100 Kg (approx 16-stone) should use a gas lift chair unless it has been specially designed to accommodate heavier people safely. (Seating at work HSE Books HSG57)

The Comfort 'U-Range'

A family of excellent back-care chairs which all cost less than £500 including VAT.

These carefully-chosen chairs have features and benefits previously unavailable, until now, for such a low price.



MULTI-SET
CHAIR

The Comfort U-490

£415.32 + VAT

(£488)

SYNCHRO
CHAIR



The Comfort U- 490

This chair contains a unique combination of back-care features never found on one chair before.

- ◆ A supremely effective and comfortable Tri-curved spine-shaped adjustable-backrest.
- ◆ A smooth, weight-adjustable **synchro** action, ending in a 4-degree forward tilt.
- ◆ An adjustable-angle backrest (**independent** of the forward tilting **synchro** action).
- ◆ Smart upholstered back
- ◆ Inflatable lumbar support
- ◆ Height and depth-adjustable arms.
- ◆ Pivoted height & depth-adjustable neck rest.
- ◆ A generous double-curved seat.
- ◆ Sliding seat depth adjustment (5cm).
- ◆ Smart chrome base with big easy-roll castors.
- ◆ Top weight limit of 150 Kg (24-stone).

Fold-away height-adjustable arms

Available as a special option at no extra cost.
Select **option AF** when ordering.

All models carry a full five year guarantee, two years for 24 hour use, subject to normal usage

Dimensions:

Seat depth; 46-51cm
Seat width; 52 cm
Overall width with arms; 68 cm
Back height top-bottom; 58 cm
Back height range; 6 cm
Back width (widest part) 49 cm;
Seat height (chrome base); 48-60 cm
Seat angle range; -10 to +4 degrees

Nobody weighing more than 100 Kg (approx 16-stone) should use a gas lift chair unless it has been specially designed to accommodate heavier people safely. (Seating at work HSE Books HSG57)

C.S.ERGONOMICS

17, Alexandria Drive,
St Annes, Lancashire, FY8 1JF.
www.the-comfort-shop.co.uk

(01253) 724902

THE COMFORT SHOP

The Comfort 'U-Range'

A family of excellent back-care chairs which all cost less than £500 including VAT.

These carefully-chosen chairs have features and benefits previously unavailable, until now, for such a low price.

4-way internal lumbar support, with adjustable depth and height



MULTI-SET CHAIR

FLOATING CHAIR

EXTRA STRONG

The Comfort U-500
£423.83 + VAT
(£498)

Extra-strong & extra-stable six-leg base with large easy-roll castors

The Comfort U- 500

- A **'floating'** action tested up to 50 Kg (24-stone)
- **Independent** actions for seat angle and back angle.
- Ergonomically contoured backrest
- Four-way adjustable lumbar support
- Adjustable-height and adjustable angle neck / headrest
- A super-strong and stable six-leg base
- Extra-large easy-roll castors
- Adjustable height armrests
- Soft-feel arm tops
- Sliding seat depth adjustment
- Standard seat cushion in plain or 'memory' foam
- Coccyx cut outs in either foam, at no extra cost
- Three quick-delivery colours (black, blue or burgundy).



Adjusts to fit users between 5ft and 6ft-3"

Dimensions:

Seat depth; 46 cm
Seat width; 51cm
Overall width with arms; 51cm
Back height top-bottom; 52 cm
Back width (widest part); 46 cm
Back height range; 9 cm
Seat height range 51-66cm

BUT, best of all... to keep things simple

Pick and mix any seat (standard or coccyx cut-out) with any foam finish plain or 'memory' foam) for the same price of just **£498 inc VAT**

The price won't change, ...just the chair!



Standard seat, plain or 'memory' foam



coccyx cut-out, plain or 'memory' foam



'memory' foam layer on either type of seat cushion at **no extra cost.**



Dual function head support or neck rest

C.S.ERGONOMICS

17, Alexandria Drive,
St Annes, Lancashire, FY8 1JF.
www.the-comfort-shop.co.uk

(01253) 724902

THE COMFORT SHOP

The Comfort 'U-Range'

A family of excellent back-care chairs which all cost less than £500 including VAT.

These carefully-chosen chairs have features and benefits previously unavailable, until now, for such a low price.



The Comfort U-Nique

£372.76 + VAT
(£438)

This unique chair has been designed so the seat and arms gently follow every movement the user makes .



Dimensions:

Seat depth; 48-52 cm
Seat width; 52 cm
Overall width with arms; 67 cm
Back height top-bottom; 56 cm
Back height range; 7 cm
Seat height range (black base); 47-55 cm
Seat height range (polished base); 47 55 cm
Top weight limit; 150Kg (24 stone)

How does it work?

Whenever you lean forwards, sideways or backwards on this chair, the seat and arms, cushioned on a special mounting, move with you. Simple and effective.



A performance seat 'memory' foam
seat cushion available as a special option at no extra cost. Select **option PF** when ordering.



Pivoted height & depth-adjustable neck rest.
Extra option for £46 + VAT
£54.05 inc VAT
Select **option SW2** when ordering.



Inflatable lumbar support
Extra option for £30 + VAT
£35.25 inc VAT
Select **option SW2** when ordering.

The U-Nique chair:

Is an innovative chair which will appeal to a wide range of customers including the 16-24 year-olds who are increasingly complaining of backache (80% in a recent study).

◆ Has a high moulded back providing constant support. The unusual seat mechanism allows the chair to respond to each small movement of the user. Movement is often said to be the key to a healthy spine and lack of movement is a primary cause of back pain.

◆ This clever 3-dimensional seat movement is particularly beneficial for people whose spine – back and neck - has reduced flexibility. Where normal spinal mobility is limited e.g. following spinal surgery or in the presence of injury or degenerative changes, there is increased strain on the discs and increased risk of injury.

◆ Allows normal circulation, helps to relieve pressure on the intervertebral discs and reduces the strain on the ligaments.

Rosemary White GRAD. DIP.PHYS.
Chartered & State Registered Physiotherapist.

Heavy-duty chairs

For people who weigh up to 250Kg (39-stone)



Extremely robust chairs in three standard sizes, developed for heavier people weighing up to **250KG (39 stone)**.

- ◆ Wool contract upholstery with genuine leather trim on seat and back edges.
- ◆ Polished aluminium base comes as standard.
- ◆ Adjustable height and depth backrest.
- ◆ Soft floor castors as standard. Hard floor castors available on request.
- ◆ Lifelong guarantee on gas lift; Five year guarantee on metal parts; two years for upholstery.



MAXX-LARGE



MAXX-MEDIUM



MAXX-SMALL

Dimensions—Large:

Weight limit: 250Kg (39St)

Seat pan: 65cm wide x 50cm deep

Back: 56cm wide x 50cm high

Seat height : 49cm (19") - 59cm (23")

Dimensions—Medium:

Weight limit: 250Kg (39St)

Seat pan: 56.5cm wide x 50cm deep

Back: 46cm wide x 50cm high

Seat height : 49cm (19") - 59cm (23")

Dimensions—Small:

Weight limit: 250Kg (39St)

Seat pan: 50cm wide x 50cm deep

Back: 46cm wide x 50cm high

Seat height : 49cm (19") - 59cm (23")

Maxxline-Large

£1,078 + VAT

£1,266.65 inc VAT

Maxxline-Medium

£1,043 + VAT

£1,225.52 inc VAT

Maxxline-Small

£1,015 + VAT

£1,192.62 inc VAT

C.S.ERGONOMICS

17, Alexandria Drive,
St Annes, Lancashire, FY8 1JF.
www.the-comfort-shop.co.uk

(01253) 724902

THE COMFORT SHOP

Heavy-duty chairs



**The Grande chair.
Designed for people
who are taller and
heavier than average.**

Big Plus-points

- ◆ For people weighing up to 190Kg (30-stone)
- ◆ For people up to 6'6" tall (or maybe more)
- ◆ Moulded 'memory' foam seat pad
- ◆ Two-way adjustable lumbar support
- ◆ Adjustable back height
- ◆ Adjustable seat depth
- ◆ Adjustable headrest
- ◆ Synchro' mechanism
- ◆ Easy-reach weight adjustment side winder
- ◆ Extra strong and stable six-star base
- ◆ Large easy-roll castors
- ◆ Flexible arms with sprung steel insert
- ◆ Elasticated Interface Extreme 24/7 fabric



**The Grande
G1-XXL**
£765 + VAT
(£898.88)

Includes headrest,
adjustable lumbar
support and arms

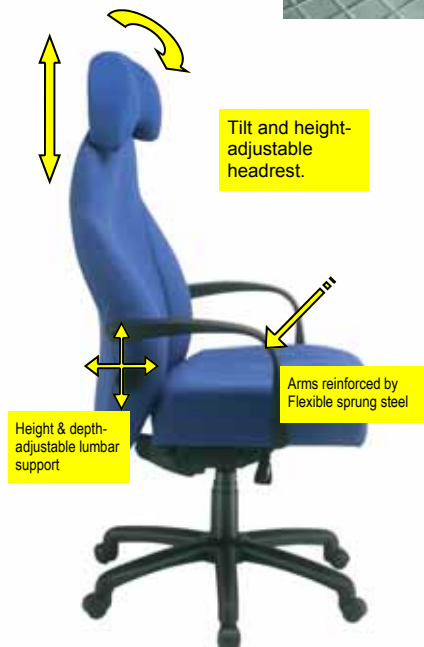

A unique memory foam seat pad combined with a resilient foam cushion core, moulds around the body, providing good comfortable support to thighs, buttocks and base of the spine.



Guarantee details:

The Grande G1-XXL is guaranteed for five years when used for up to eight hours a day by people up to 30 stone. It is guaranteed for 18 months when used 24-7 (over 8 hours a day) by people up to 30 stone. A longer two-year 24/7 guarantee period can be obtained by paying £50 + VAT on top of the normal retail price. Details available on request.

Dimensions:

Seat cushion width; 56cm
Seat cushion depth; 54 cm
Seat slide range;
Back width; 56 cm
Back height; 66cm
Seat height range;
Fixed arm height;
(cushion top to arm top)

Nobody weighing more than 100 Kg (approx 16-stone) should use a gas lift chair unless it has been specially designed to accommodate heavier people safely. (Seating at work HSE Books HSG57)

Heavy-duty chairs



For weights up to 190kg (30 stone)

The Therapod 7470.
A smart, modern
and very strong chair



Status



Therapod 7470
Including height-
adjustable arms
£625 + VAT
(£734.38)

Dimensions of Therapod 7470:

Adjustable seat depth: 48cm-53cm (19-21")
Seat cushion width: 60cm (23.5")
Seat Height (minimum, user seated): 42cm (16.5")
Seat Height (maximum, user seated): 55cm (21.5")
Back width (maximum): 50cm (19.75")
Back height from seat (min): 55cm (21.5")
Back height from seat (max): 62cm (24.5")
Inside width between arms: 58cm (23")
Height of arm from ground (min): 65cm (25.5")
Height of arm from ground (max): 78cm (30.75")

Features:

- ◆ Incorporates System Therapod adjustable strapping, so seat back can be shaped to suit the user.
- ◆ Extra-side seat width 60cm (23.5"), backed by 1cm laminated plywood base.
- ◆ Adjustable seat depth 48-53cm
- ◆ Extra heavy-duty height-adjustable arms
- ◆ Upgraded gas lift will support 190Kg
- ◆ Extra-thick, high-density 10cm (4") pressure-sensitive seat foam
- ◆ Heavy-duty 28" polished aluminium base
- ◆ British-made synchro seat mechanism, with eight tension control settings
- ◆ Seven angle settings for backrest
- ◆ 23-degree backrest recline
- ◆ 16-degrees of seat movement, from 4 degrees sloped forward to 12-degrees back
- ◆ Anti-kickback safety feature.



Therapod 7478
Extra-high back
Including height-
adjustable arms
£675 + VAT
(£793.14)



Dimensions of Therapod 7478:

Same as above except for:

Back height from seat (min): 72cm (28.25")

Back height from seat (max): 81cm (32")

* Chair comes with standard adjustable-height leather neck support on a weighted strap.



Nobody weighing more than 100 Kg (approx 16-stone) should use a gas lift chair unless it has been specially designed to accommodate heavier people safely. (Seating at work HSE Books HSG57)

Heavy-duty chairs



Tough chairs from Texas

BodyBilt chairs

Designed to meet unusual needs

& weights up to 225kg (35.5 stone)

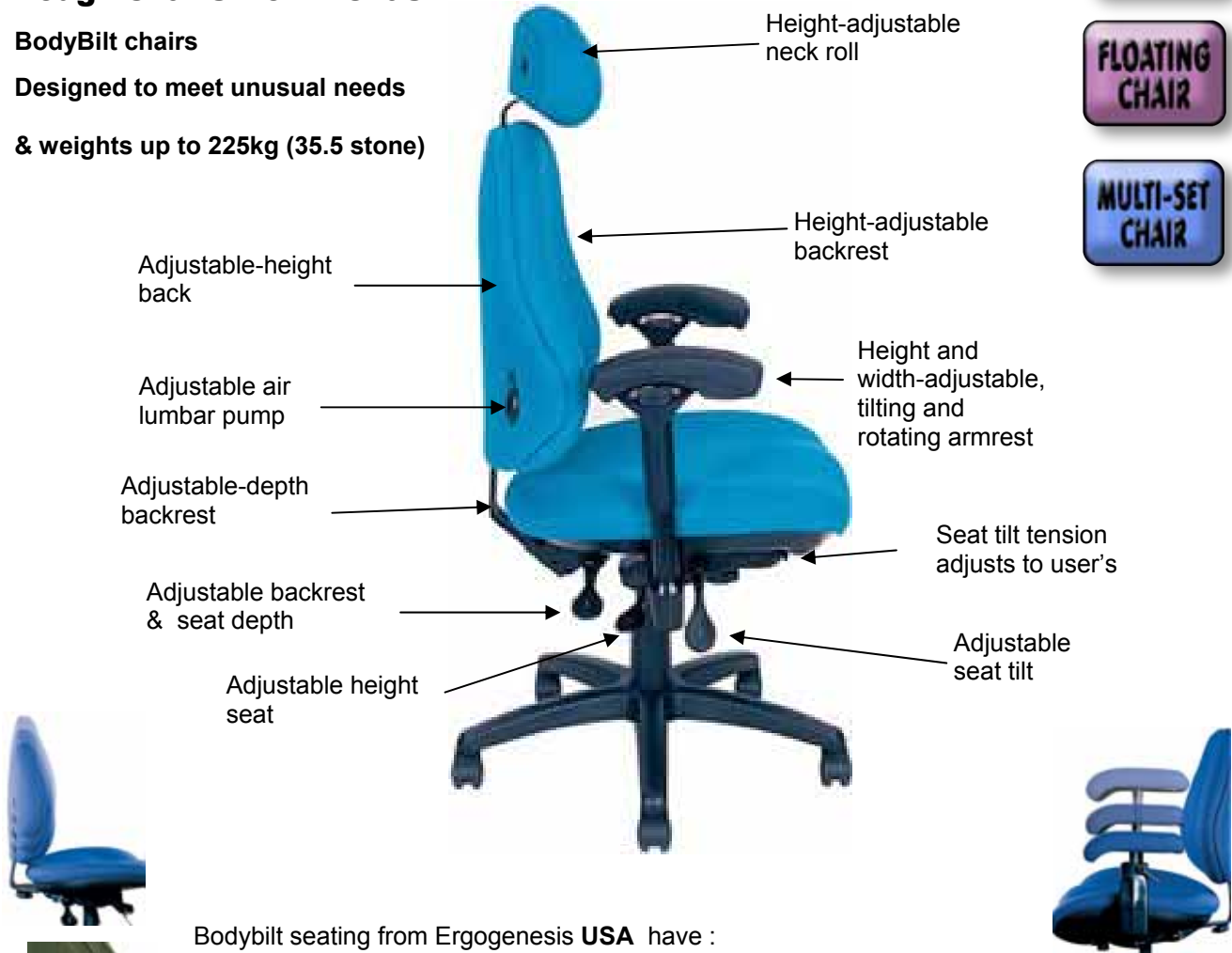

Bodybilt seating from Ergogenesis **USA** have :

- ◆ 10-point posture control; which is ten different active ergonomic adjustments to give each user the tools to achieve a personalised fit.
- ◆ A wide selection of contoured seat pans to suit all shapes and sizes.
- ◆ Good back support provided by, lateral wrap, from contoured chair backs and an adjustable air lumbar support , to give the required degree of firmness.



Nobody weighing more than 100 Kg (approx 16-stone) should use a gas lift chair unless it has been specially designed to accommodate heavier people safely. (Seating at work HSE Books HSG57)

Heavy-duty chairs

For weights up to 225kg (35.5 stone)



J 3504

BodyBilt Big & Tall chairs

With unique features for users of above average height and weight.

- ◆ Steel reinforced seat
- ◆ Larger than average seat pan; 22% larger & 66cm (26") wide).
- ◆ Contoured seat (size 4) to help spread user's weight.

Big & Tall J3504
£1,099 + VAT
(£1,291.32)
Price including neck rest,
inflatable lumbar support
and arms

Contoured seat size 4:
Depth: 53.3cm (21")
Width: 66cm (26")
Passive weight distribution
and high durability



J 2504

Big & Tall J2504
£999 + VAT
(£1,173.83)
Price without
neck rest but with
inflatable lumbar
support and arms

High-Back:

- Length: 55.9cm (22")
- Width: 54.6 cm (21.5")
- Lumbar range
(overall): 10.2cm (4")
(high): 26.7cm (10.5")
(low): 16.5cm (6.5")
- Lumbar Width: 35.6cm (14")

Quick delivery colours:
black; navy blue; royal
blue; burgundy or grey



Supplied with seat mechanism (J):

- Rocks from a central pivot under the seat.
- Sliding seat depth
- Forward tilt: 5 degrees
- Rearward tilt: 11 degrees
- Tilt range 16 degrees.
- Seat height (Low); 40.6cm (18")
- Seat height (high): 54.6cm (21.5").

BodyBilt Extra Tall chairs

- ◆ Extra-long seat (58.4cm wide and 58.4cm deep (23"x23") to suit users over taller than 6'3".
- ◆ Moderately contoured seat (size 9) to help spread user's weight.
- ◆ High-Back, with or without neck rest or smaller Mid-Back



J 3509

The S-t-r-e-t-c-h

High-Back (J3509)
including neck rest,
inflatable lumbar support
and arms
£ 1099 + VAT
(£1,291.32)

High-Back (J2509)
without neck rest,
but including inflatable
lumbar support and arms
£ 999+VAT
(£1,173.82)

High-Back (Pictured left):

- Length: 55.9cm (22")
- Width: 54.6 cm (21.5")
- Lumbar range (overall):10.2cm (4")
(high): 26.7cm (10.5")
(low): 16.5cm (6.5")
- Lumbar Width: 35.6cm (14")

Quick delivery colours:
black; navy blue; royal
blue; burgundy or grey



Supplied with seat mechanism (J):

Nobody weighing more than 100 Kg (approx 16-stone) should use a gas lift chair unless it has been specially designed to accommodate heavier people safely. (Seating at work HSE Books HSG57)

Heavy-duty chairs

For weights up to 133kg (21 stone)

BodyBilt High-back chairs

With unique features for users of above average height and weight.
 ♦ Same back options and seat mechanisms as the Big & Tall chairs (previous page) but with more **moderately-contoured** standard (size 7) seats.



J 3507

Moderately contoured seat (size 7):
 Depth: 48.3cm (19")
 Width: 53.3cm (21")
 Passive weight distribution and close anatomical 'fit'



High Back J3507
 £899 + VAT
(£1,056.32)
 Price **including** neck rest, inflatable lumbar support and arms

High Back J2507
 £799 + VAT
(£938.82)
 Price **without** neck rest but with inflatable lumbar support,



Quick delivery colours: black; navy blue; royal blue; burgundy or grey

Quick delivery colours: black; navy blue; royal blue; burgundy or grey



Very Small Chairs

BodyBilt Petite chairs

- ♦ Reduced dimension seat 44.5cm deep x 47cm wide (17.5" x 18.5")
- ♦ Minimal contour petite seat (size 6)
- ♦ Suits users between 4'9" and 5'3"
- ♦ Special custom-builds for people between 4'- 4'9"
- ♦ Adapts to almost every body type and practically any



J 756

Supplied with seat mechanism (J): and back-depth adjustment



Mid-Back:

- Length: 47cm (18.5")
- Width: 47 cm (18.5")
- Lumbar range (overall): 10.2cm (4") (high): 26.7cm (10.5") (low): 16.5cm (6.5")
- Lumbar Width: 35.6cm (14")

Mid-Back (J756)
 Price Includes inflatable lumbar support, arms and petite 6-size seat
 £ 599 + VAT
(£ 703.82)

Adapt—600 range chairs With knee-tilt action

FLOATING CHAIR

MULTI-SET CHAIR



Headrest (HR)

This mid-price high-back chair comes with the following standard features:

- ◆ A knee-tilt mechanism, which allows the user to float forwards towards a working position, or backwards for a 'think', while all the time allowing the user's feet to remain firmly on the floor.
- ◆ Independent seat and back angle adjustment.
- ◆ Inflatable lumbar support.
- ◆ Sliding adjustable seat depth.
- ◆ Memory foam seat pad.
- ◆ Either a neck roll or a headrest.



The Adapt 600 range also has:

- ◆ **Two** choices of seat depth
- ◆ **Three** choices of back height;

Seats and backrests are interchangeable to obtain a perfect user fit every time.

Adapt 640-680s have generous seats:

Adapt—660

Shown with standard: adjustable head rest, height-adjustable arms, inflatable lumbar support and memory foam seat
£515 + VAT (**£605.13**)

These chairs can take up to 152Kg (24-stone)



Adapt-640
£395 + VAT



Adapt-650
£405 + VAT



Adapt-660
£415 + VAT



Adapt-680
£465 + VAT

Extra-large

Prices without options (below)

Dimensions:

Standard seat depth:	47-53.5cm	47-53.5cm	47-53.5	58-63cm
Standard seat width:	50cm	50cm	50cm	61cm
Back height (above seat to top):	39.5-44.5cm	50.5-55.5cm	60-65cm	63-69cm
Back width:	44cm	44cm	44cm	51cm
Overall chair width including arms:	53cm	53cm	53cm	64cm
Overall chair depth:	68cm	68cm	68cm	82cm

Seat Options:

	Code:	£	£	£	£
Sprung seat	SPR	20	20	20	20
Split seat	SPL	120	120	120	120
Coccyx cut-out	CC	10	10	10	10
Inflatable thigh support	TS	20	20	20	20
Extra-large seat (54cm wide x 51 deep)	ELS	20	20	20	20
Extra-small seat (44 cm wide x 43 deep)	ESS	20	20	20	20

Back Rest Options:

	Code	£	£	£	£
Reactive Lumbar Support	3LUM	32	32	32	32
Thoracic lumbar support	THO	n/av	20	20	20
Vertical Support					
Left or Right or both (inflatable)	VSL/VSR	16 each	16 each	16 each	16 each
'Memory foam' back	MFB	22	22	22	22

Arm Options:

	Code	£	£	£	£
Height-adjustable arms	HAA	40	40	40	40
Width-adjustable arms	WAA	20	20	20	20
Mobile support arms (pair)	MSA	100	100	100	100
Retractable ht-adj arms	RET	60	60	60	60
Gel pad arms	GEL	20	20	20	20

Head Supports:

	Code	£	£	£	£
Neck Roll (smaller)	NR	n/av	60	60	60
Head Rest (flatter)	HR	n/av	60	60	60

★ Quick delivery in black or dark blue one week from receiving your order.

C.S.ERGONOMICS

17, Alexandria Drive,
St Annes, Lancashire, FY8 1JF.
www.the-comfort-shop.co.uk

(01253) 724902

THE COMFORT SHOP

Adapt—600 range chairs With knee-tilt action

FLOATING CHAIR

MULTI-SET CHAIR



neck roll (NR)

This mid-price high-back chair comes with the following standard features:

- ◆ A knee-tilt mechanism, which allows the user to float forwards towards a working position, or backwards for a 'think', while all the time allowing the user's feet to remain firmly on the floor.
- ◆ Independent seat and back angle adjustment.
- ◆ Inflatable lumbar support.
- ◆ Sliding adjustable seat depth.
- ◆ Memory foam seat pad.



The Adapt 600 range:

- ◆ **Two** choices of seat depth
 - ◆ **Three** choices of back height;
- Seats and backrests are interchangeable

Adapt—630

Shown as a basic chair **without** usual arm options etc.,
 £405 + VAT (**£475.87**)
 Priced **with** height-adjustable arms (HAA) and Neck Roll (NR)

These chairs can take up to 152Kg (24-stone)

Adapt 610-630s have narrow and short seats:



Adapt-610
 £385 + VAT

Adapt-620
 £395 + VAT

Adapt-630
 £405 + VAT

Prices without options (below)

Dimensions:

Standard seat depth:	43-49cm	43-49.5cm	43-49.5cm
Standard seat width:	46cm	46cm	46cm
Back height (above seat to top):	39.5-44.5cm	50.5-55.5cm	60-65cm

Seat Options:

	Code:	£	£	£
Sprung seat	SPR	20	20	20
Split seat	SPL	120	120	120
Coccyx cut-out	CC	10	10	10
Inflatable thigh support	TS	20	20	20
Extra-large seat (54cm wide x 51 deep)	ELS	20	20	20
Extra-small seat (44 cm wide x 43 deep)	ESS	20	20	20

Back Rest Options:

	Code	£	£	£
Reactive Lumbar Support	3LUM	32	32	32
Thoracic lumbar support	THO	n/av	20	20
Vertical Support				

Left or Right or both (inflatable)	VSL/VSR	16 each	16 each	16 each
'Memory foam' back	MFB	22	22	22

Quick delivery in black or dark blue one week from receiving your order.

Arm Options:

	Code	£	£	£
Height-adjustable arms	HAA	40	40	40
Width-adjustable arms	WAA	20	20	20
Mobile support arms (pair)	MSA	100	100	100
Retractable ht-adj arms	RET	60	60	60
Gel pad arms	GEL	20	20	20

Head Supports:

	Code	£	£	£
Neck Roll (smaller)	NR	n/av	60	60
Head Rest (flatter)	HR	n/av	60	60

★ Quick delivery in black or dark blue one week from receiving your order.

Adapt—500 chairs An Asynchronous action chair



This mid-priced high-back chair comes with the following standard features:

- ◆ A forward-tilting seat mechanism, with independent backrest angle adjustment
- ◆ Inflatable lumbar support.
- ◆ Sliding adjustable seat depth.
- ◆ Memory foam seat pad.
- ◆ Either a neck roll or a headrest.



These chairs can take up to 152Kg (24-stone)

The Adapt 500 range also has:

- ◆ **Two** choices of seat depth 46 cm or 50 cm
- ◆ **Two** choices of back height;

Seats and backrests are interchangeable to obtain a perfect user fit every time.

Adapt—540
Shown with height-adjustable arms (HAA) and Neck Roll (NR)
£400 + VAT (**£470**)



Prices without options	Adapt-510 £270+VAT	Adapt-520 £280+VAT	Adapt-530 £290+VAT	Adapt-540 £300+VAT
Dimensions:				
Standard seat depth:	43-48.5cm	43-48.5	47-53.5	47-53cm
Standard seat width:	46cm	46cm	50cm	50cm
Back height (above seat to top):	50-58cm	59-67cm	50-58cm	59-67cm
Back width:	53cm	53cm	57cm	57cm
Overall chair depth:	68cm	68cm	68cm	68cm

Seat Options:	Code:	£	£	£	£
Sprung seat	SPR	20	20	20	20
Split seat	SPL	120	120	120	120
Coccyx cut-out	CC	10	10	10	10
Inflatable thigh support	TS	20	20	20	20
Extra-large seat (54cm wide x 51 deep)	ELS	20	20	20	20
Extra-small seat (44 cm wide x 43 deep)	ESS	20	20	20	20
Back Rest Options:	Code	£	£	£	£
Reactive Lumbar Support	3LUM	32	32	32	32
Thoracic lumbar support	THO	n/av	20	20	20
Vertical Support					
Left or Right or both (inflatable)	VSL/VSR	16 each	16 each	16 each	16 each
'Memory foam' back	MFB	22	22	22	22
Arm Options:	Code	£	£	£	£
Height-adjustable arms	HAA	40	40	40	40
Width-adjustable arms	WAA	20	20	20	20
Mobile support arms (pair)	MSA	100	100	100	100
Retractable ht-adj arms	RET	60	60	60	60
Gel pad arms	GEL	20	20	20	20
Head Supports:	Code	£	£	£	£
Neck Roll (smaller)	NR	60	60	60	60
Head Rest (flatter)	HR	60	60	60	60

Adapt—700 chairs

A Synchronous action chair



This elegant high-back chair comes with the following standard features:

- ◆ A centrally-pivoting seat mechanism (pelvic tilt), with independent backrest angle adjustment
- ◆ Inflatable lumbar support.
- ◆ Sliding adjustable seat depth.
- ◆ Memory foam seat pad.
- ◆ Either a neck roll or a headrest.

The Adapt 700 range:

- ◆ **Two** choices of seat depth
- ◆ **Two** choices of back height;

Seats and backrests are interchangeable to obtain a perfect user fit every time.

Adapt—740 Shown with height-adjustable arms (HAA) and Neck Roll (NR)
£490 + VAT (**£575.75**)



Prices without options (below)

Dimensions:

Standard seat depth:	43-48cm	43-48cm	48-54cm	48-54cm
Standard seat width:	48cm	48cm	52cm	52cm
Back height (above seat to top):	45-52cm	50-57cm	45-52cm	50-57cm
Back width:	46cm	49cm	46cm	49cm
Overall chair width including arms:	60cm	70cm	60cm	70cm
Overall chair depth:	60cm	70cm	60cm	70cm

Adapt-710
£370 + VAT

Adapt-720
£380 + VAT

Adapt-730
£380 + VAT

Adapt-740
£390 + VAT

Seat Options:	Code:	£	£	£	£
Sprung seat	SPR	20	20	20	20
Split seat	SPL	120	120	120	120
Coccyx cut-out	CC	10	10	10	10
Inflatable thigh support	TS	20	20	20	20
Extra-large seat (54cm wide x 51 deep)	ELS	20	20	20	20
Extra-small seat (44 cm wide x 43 deep)	ESS	20	20	20	20
Back Rest Options:	Code	£	£	£	£
Reactive Lumbar Support	3LUM	32	32	32	32
Thoracic lumbar support	THO	n/av	20	20	20
Vertical Support					
Left or Right or both (inflatable)	VSL/VSR	16 each	16 each	16 each	16 each
'Memory foam' back	MFB	22	22	22	22
Arm Options:	Code	£	£	£	£
Height-adjustable arms	HAA	40	40	40	40
Width-adjustable arms	WAA	20	20	20	20
Mobile support arms (pair)	MSA	100	100	100	100
Retractable ht-adj arms	RET	60	60	60	60
Gel pad arms	GEL	20	20	20	20
Head Supports:	Code	£	£	£	£
Neck Roll (smaller)	NR	60	60	60	60
Head Rest (flatter)	HR	60	60	60	60

Chairs with Movement and Swivel Locks

CUSTOMISED
CHAIR



The Adapt—660
Shown with a **Movement Lock** and battery-operated hand control. Designed to stop an office chair moving around the floor when getting on and off it etc.. With adjustable neck roll, height-adjustable arms, inflatable lumbar support and memory foam seat
£755 + VAT (**£887.13**)

The office chair pneumatic Movement Lock:

- ◆ Can be retro-fitted to any chair that uses a 5-star base with a standard 17-4 gas lift aperture in its chassis.
- ◆ It works by inflating an air cell between two steel plates, which forces five anti-slip feet firmly onto the floor.
- ◆ It is controlled by manual hand pump, or by a
- ◆ Battery-powered mini-pump for those with weak grip.
- ◆ The movement lock comes fitted with a non-swivelling height-adjustable gas lift.



Swivel lock

Chair swivel lock:

If a user wishes to keep their original swivelling gas lift when the Movement Lock is retro-fitted to their chair, they will probably need the manually-operated Swivel Lock.

Movement Lock

£240 + VAT (**£282**)

Swivel Lock

£36 + VAT (**£42.30**)

Chairs with Split Seat Options

CUSTOMISED
CHAIR



Split seats can be fitted to the Adapt 500, 600 and 700 ranges
Add £120 + VAT (**£141**)
to your chosen chair's listed price.



Contact us with all your questions about these excellent mid-priced chairs

The hinged front flaps are lockable in 10 degree increments to a maximum deflection of 40 degrees
Left and right sides can be individually adjusted.
So, for example, one side could be dropped 30 deg and the other by 10.

C.S. ERGONOMICS

17, Alexandria Drive,
St Annes, Lancashire, FY8 1JF.
www.the-comfort-shop.co.uk

(01253) 724902

THE COMFORT SHOP

More popular options for Adapt 500, 600 & 700 chairs



Rotating arms (ROT)



Retractable arm pad (RET)



Gel arm pd (GEL)



Short Pad (21cm) (SAP)



Retractable lift & twist



P-shaped padded



Width-adjustable arms



Mobile support arms (MSA)



Coccyx cut-out (CC)



Extra deep seats (specials)



Head rest (HR)



Neck roll (NR)

Inflatable air cells for back and thighs



Memory foam back rest



Inflatable thigh supports left / right or both (TS)



Reactive 3-cell lumbar support For lower to upper back (3LUM)



Thoracic support (THO) or vertical support left right or both

Contact us about massage in chairs or full catalogue.



Massage options



Foot ring (F/RING)



Foot ring/plate (FTP)



Free-standing leg rest



The RH Logic 300



The RH Logic 300 is a smaller version of the successful Logic 400 (see next page) Its design is inspired by the human body's knee and hip joints.

The RH Logic 300 has many new features to encourage active and variable sitting:

- ◆ Easy-to-reach float action weight adjustment
- ◆ A new slimmer, contoured backrest
- ◆ A more adjustable neckrest
- ◆ Extra sliding seat depth
- ◆ A softer, yet still supportive seat
- ◆ Pictures on chair control levers
- ◆ Replaceable seat and back upholstery pads

FLOATING CHAIR

MULTI-SET CHAIR

The RH Logic 300
 £665 + VAT (**£781.38**)
 Including inflatable lumbar support, standard height and width-adjustable arms with sliding-depth tops

RH Logic 300 chairs have won the prestigious FIRA Ergonomics Excellence Award for office chairs (2005, 2006 and 2007) (FIRA is the UK's Furniture Industry Research Association)



The RH Logic 300 with neck rest

£706 + VAT (**£829.55**)
 Including inflatable lumbar support and standard arms

Handy clip-on coat hanger
 £26 + VAT (**£30.55**)



Standard arms: 21.5-29.5cm
 Adjustable height and width, with sliding-depth tops
 £72 + VAT (**£84.60**) (pair)



Extra-low arms: 20-28cm
 Adjustable height and width, with sliding-depth tops
 £72 + VAT (**£84.60**) (pair)



Swivel-top arms:
 Adjustable height and width
 £72 + VAT (**£84.60**) (pair)



Relax 3-D floating armrests
 £206 + VAT (**£242.05**) (pair)



'Green' chairs

Did you know RH chairs are **100% recyclable?**

Dimensions, specifications and guarantees:
 For RH400 and RH300 chairs are on page 25
 For a full range of colours, see our website.

RH Logic 400



The RH Logic 400 is the latest evolution of our top-selling chair, the RH4 (page 26)

Its design is inspired by the human body's knee and hip joints.

The RH Logic 400 has many new features to encourage active and variable sitting:

- ◆ Easy-to-reach float action weight adjustment
- ◆ A new slimmer, contoured backrest
- ◆ A more adjustable neck rest
- ◆ Extra sliding seat depth
- ◆ A softer, yet still supportive seat
- ◆ Pictures on chair control levers
- ◆ Replaceable seat and back upholstery pads

FLOATING CHAIR

MULTI-SET CHAIR



The RH Logic 400
 £757 + VAT (**£889.48**)
 Including inflatable lumbar support, neck rest and standard arms

Handy clip-on **coat hanger**
 £26 + VAT (**£30.55**)



RH Logic 400 chairs have won the prestigious FIRA Ergonomics Excellence Award for office chairs (2005 /6 & 2007 (FIRA is the UK's Furniture Industry Research Association)

Standard arms: 21.5-29.5cm
 Adjustable height and width, with sliding-depth tops
 £72 + VAT (**£84.60**) (pair)



Extra-low arms: 20-28cm
 Adjustable height and width, with sliding-depth tops
 £72 + VAT (**£84.60**) (pair)



Swivel-top arms:
 Adjustable height and width
 £72 + VAT (**£84.60**) (pair)



Relax 3-D floating armrests
 £206 + VAT (**£242.05**) (pair)



Inflatable Lumbar support
 £30 + VAT (**£35.25**)



The Rh Logic 400 **without neckrest**
 £696 + VAT (**£817.80**)
 Including inflatable lumbar support and standard arms

Dimensions, specifications and guarantees:
 For RH400 and RH300 chairs are on page 25
 For a full range of colours, see our website.

The RH Logic 300 and 400 chairs in leather



The Rh Logic 400 (leather)
 £917 + VAT (**£1,077.48**)
 Including inflatable lumbar support,
 neck rest and standard arms

The Rh Logic 300 (leather)
 £848 + VAT (**£996.40**)
 Including inflatable lumbar support,
 neck rest and standard arms

Text on leather chairs
 Standard leather finish leaves the chair's
 plastic back shell showing.
 To completely cover the back shell with
 leather, order the Elegance finish (see chair
 back on the right)

For matching leather-trimmed
 arm tops, add
 £32+ VAT (**£37.60**)



The RH Logic 400 and 300 24/7 chairs



The RH Logic 300 24/7
 £707 + VAT (**£830.73**)
 Including inflatable lumbar sup-
 port, neck rest and
 standard arms

For a neck rest on this Rh chair,
 add £41 + VAT (**£48.18**)

To meet the demanding needs of a
24/7 work environment, the 24-
 hour version of the RH Logic 300
 and 400 have a considerably
 thicker wool fill in the seat com-
 pared to the standard chair.
 There is also extra padding in the
 back rest
 Both seat and back rest have im-
 proved ventilation too.
 The seat and back rest are easy to
 replace when necessary.



For 24/7 chairs, a stronger
 range of fabrics are used.
 Details on request



The RH Logic 400 24/7
 £806 + VAT (**£947.05**)
 Including inflatable lumbar support,
 neck rest and standard arms



The RH Logic 300 and 400 Elegance chairs



**FLOATING
CHAIR**

**MULTI-SET
CHAIR**



All RH 300 and 400 Elegance models can have their standard plastic back shells covered in matching fabric or leather. This style is called the Elegance finish and costs approximately 15% more. **Price on application**

Winner of FIRA International Awards for Ergonomic Excellence in 2005, 2006 & 2007 (FIRA is the UK's Furniture Industry Research Association).



Detailed manufacturer's brochures of all Rh models are available on request



**Inflatable
Lumbar support**
£30 + VAT (**£35.25**)



Special Products for RH 300 and RH 400 chairs

Code	Description	Price (extra)
S7	'Memory' visco-elastic foam in seat pad	£165 + VAT (£193.87)
S15	Coccyx cut-out (seat)	£ 81 + VAT (£95.18)
XL	Extra Large seat width 48.5cm; depth 51.5cm; seat slide 6cm	£40 + VAT (£47.00)
8E	Leather-topped armrests (pair)	£104 + VAT (£122.20)
7H/65mm	Castors (with urethane tyres) for concrete floors	£10 + VAT (£17.50)



Dimensions	RH 400	RH 300
Seat depth	40-46cm	40-46cm
Seat slide	6cm	6cm
Depth of seat pad	47.5cm	47.5cm
Seat width	46.5cm	46.5cm
Seat angle adjustment (both chairs)	+14 / -7degrees	
Height of lumbar support above seat	17-29.5cm	14-26.5cm
Height of backrest	63cm	50cm
Width of backrest	44.5cm	44.5cm
Backrest angle adjustment (both chairs)	to 15 degrees	
Height of armrests above seat (both chairs)	21-29cm	
Space between armrests (both chairs)	38.5—51.5cm	
Diameter of base (both chairs)	66cm	

'Green' chairs

Did you know RH chairs are **100% recyclable?**

RH Logic 400 and 300 chairs have undergone extensive testing for the ergonomics, structural and safety requirements of the appropriate British and European standards and FIRA International specifications. All RH Logic chairs are tested and guaranteed to a weight of 23.5 stone (149Kg). The RH Logic 400 is suitable for a wide range of office and computer environments. It is tested and approved for control room use according to ISO 7173:1989

Guarantees. RH300 & 400 chairs are guaranteed for **five** years. They are tested and approved in accordance with BS 5459: (2000): Pat 2, EN-1335 1,2,3, and TCO'04 Office Furniture 2004. The chairs are guaranteed for **two** years when subjected to 24-hour use with a designated 24/7 fabric. All RH chairs are recyclable. Full details on request

C.S.ERGONOMICS

17, Alexandria Drive,
St Annes, Lancashire, FY8 1JF.
www.the-comfort-shop.co.uk

(01253) 724902

THE COMFORT SHOP

RH Logic 4 and RH Logic 3 chairs



These chairs have been our top-selling product for more than a decade.

They offer reliable support and are the chair of choice for ergonomists, physiotherapists, occupational therapists, chiropractors, osteopaths throughout the UK and the rest of Europe.



The RH4
 £767 + VAT (**£901.23**)
 Including inflatable lumbar support, neck rest, height-adjustable and swivel-top arms

Without neck rest—deduct
 £38 + VAT (**£44.65**)



Winner of FIRA International Awards for Ergonomic Excellence every year from 2000 to 2007. (FIRA is the UK's Furniture Industry Research Association).



Sitting with upright posture helps to stop your lungs and diaphragm from being compressed. This promotes good blood circulation and helps you breathe more easily. Your inter-vertebral discs are under optimal pressure, which reduces discomfort in your neck and lower back. Your pelvis adopts an open angle, which assists circulation in your legs, knees and feet, while helping you to keep an upright posture.

Standard arms: 21.5-29.5cm
 Adjustable height and width, with sliding-depth tops
 £72 + VAT (**£84.60**) (pair)



Extra-low arms: 20-28cm
 Adjustable height and width, with sliding-depth tops
 £72 + VAT (**£84.60**) (pair)



Swivel-top arms:
 Adjustable height and width
 £72 + VAT (**£84.60**) (pair)



The RH3
 £632 + VAT (**£742.60**)
 Including inflatable lumbar support, height-adjustable and swivel-top arms



Relax 3-D floating armrests
 £206 + VAT (**£242.05**) (pair)



[Click HERE](#)
 (on this page in our online web catalogue) for RH Logic 3, 4 & RH Activ dimensions

More optional extras for RH 3 & 4 chairs can be found on page 28

The RH Activ chairs



The same upholstery as our top-selling RH3 & RH4 chairs (page 27), combined with a simpler multi-set mechanism.

RH Activ chairs are suitable for:

- ◆ Long-term monotonous computer and mouse work
- ◆ Shared workstations
- ◆ Telesales and communications work
- ◆ Counter and desk work
- ◆ Any type of job where the user doesn't move about too much, but wants a chair to care for their back.

Winner of FIRA International Awards for Ergonomic Excellence every year from 2000 to 2007. (FIRA is the UK's Furniture Industry Research Association).



The RH3 Activ
£ 470+ VAT (**£ 552.25**)
With standard height-adjustable arms



The RH2 Activ
£ 433 + VAT (**£508.78**)
With standard height-adjustable arms



The RH1 Activ
£ 398 + VAT (**£ 467.65**)
With standard height-adjustable arms

Standard arms: 21.5-29.5cm
Adjustable height and width, with sliding-depth tops
£72 + VAT (**£84.60**) (pair)



Swivel-top arms:
Adjustable height and width
£72 + VAT (**£84.60**) (pair)



Extra-low arms: 20-28cm
Adjustable height and width, with sliding-depth tops
£72 + VAT (**£84.60**) (pair)



Relax 3-D floating armrests
£206 + VAT (**£242.05**) (pair)



Special Products for RH Logic 3, RH Logic 4 & RH3 Activ chairs

Code	Description	Price (extra)
R4	3cm extra-thick foam (on back pad)	£81 + VAT (£95.17)
R5	3cm extra-soft foam (on back pad)	£62 + VAT (£72.85)
S1	3cm extra foam (thicker) seat pad	£81 + VAT (£95.17)
S4	3cm extra padding (softer) seat pad	£72 + VAT (£84.60)
8E	Leather-topped armrests (pair)	£104 + VAT (£122.20)
7H/65mm	Castors (with urethane tyres) for concrete floors	£10 + VAT (£17.50)
	Footring	£ 43 + VAT (£50.52)



[Click HERE](#)
(on this page in our online web catalogue) for RH Logic 3, 4 & RH Activ dimensions

The RH Extend chairs



A smart chair which combines a floating-type action with a sophisticated ‘synchro’ movement.

Articulation points on this chair correspond to the knee, hip and lower back. They are mechanically linked together, giving a smooth action, which follows the body’s movements.

What makes this chair different from more basic ‘synchro’ models is the seat slides backwards as the user leans backwards, so the height and contact of the backrest remain constant against the user’s back.

The RH Extend high back
 £ 459 + VAT (**£ 539.33**)
 Including neck rest and height-adjustable arms



If you *don't* want an RH Extend headrest on the high back, **deduct** its cost from price £ 72+ VAT (**£ 84.60**)
 If you *do* want the headrest on a medium back chair, just **add its cost to the basic price.**

Extend chairs can be supplied with any arms from the RH range (see page 28)



The RH Extend medium back
 £ 414+ VAT (**£ 486.45**)
 Including height-adjustable arms

Dimensions:

	RH Extend (Medium)	RH Extend (Large)
Sitting depth	40-46 cm	40-46 cm
Seat depth	47.5 cm	47.5 cm
Seat height	40.5-51 cm	40.5-50 cm
Seat width	46.5 cm	46.5 cm
Adjustability of seat angle	-9 to +5 degrees	-9 to +5 degrees
Height of lumbar pad above seat	16.5-25 cm	16.5-20 cm
Height of backrest	51 cm	62.5 cm
Width of backrest	44 cm	44 cm
Backrest angle adjustability	21 degrees	21-degrees
Height of armrests above seat	21-29 cm	21-29 cm
Space between armrests	38.5-51.5 cm	38.5-51.5 cm
Diameter of base	66 cm	66 cm



All prices are **EXCLUDING VAT**

Special Products 2008

Backrest



Article	Code		
750214	R4	30mm extra thick foam All backrests except Moveon/Extend/400/300	£81.00
750215	R5	30mm extra soft foam All backrests except Moveon/Extend/400/300	£62.00
750217	R7	Fitted Lumbar pump on 3J back – Activ 3 Only	£89.00
750213	R3	Extra lumbar padding - RH 2	£40.00
750212	R2	R2 No Bump in the back – RH 3	£81.00

Seat



750230	S1	30mm extra foam (thicker seat pad) Only for: RH3/RH4	£81.00
750231	S4	30mm extra padding (softer seat pad) Only for: RH3/RH4	£72.00
750232	S7	Memory Foam Available on RH 300/400	£165.00
750234	S15	Coccyx cut out Available on RH 300/400	£81.00

Mechanism



750271	B20	Left hand control Logic 3-4	£500.00
750255	B4	Limited rocking function Logic 3-4	£62.00
750257	B6	Left hand control Activ 2-3	£188.00
750252	B2	Armrest fitting on support 3G	£87.00
750254	B3	Left hand control 3H, 3G (not available for 3A/3B)	£81.00

Footrest

750290	F1	Foot rest for Activ Mechanism – Activ 2-3	£51.00
--------	----	---	--------

Comfort 800 Series With spring-controlled actions



Comfort RAB830
High back, R-type adjustable headrest & inflatable lumbar support
£ 565 + VAT
(£ 663.88)

Choose arms and add to price



Comfort RAB820
High back & inflatable lumbar support
£ 499 + VAT
(£ 586.33)

Choose arms and add to price



Comfort RAB815
Medium back & inflatable lumbar support
£ 478 + VAT
(£ 561.65)

Choose arms and add to price

**Five year guarantee in normal office use.
Recommended maximum user weight of 120Kg (approx 18.5 stone)**



Spring-controlled 800 Series chairs

- ◆ Rabami chairs have good ergonomics, elegance and strength. You get a 'high-end' of the market chair for an attractive price.
- ◆ A very well profiled lower backrest gives ample support right where it matters.
- ◆ Deep 6cm padding in the seat and back give an initial feeling of softness, accompanied by reassuring firmer underlying support.
- ◆ The spring-powered seat, back and float actions respond more quickly and more positively than chairs with gas-dampened effects.
- ◆ All models have sliding seat depth fitted as standard.

These models are also available with gas-dampened seat and back actions, for users who wish to avoid any sudden movements when adjusting their chair.

OPTIONAL FEATURES AVAILABLE



RAB4830
Multi-adjustable arms (height, depth, angle and width)
cost £ 71 + VAT
(£ 83.43)



RAB4851
Saturn arms
Height & width-adjustable
cost £ 64 + VAT
(£ 75.20)



RAB4801
Jupiter arms
Height & width-adjustable
cost £ 77 + VAT
(£ 90.48)



Inflatable lumbar support
£ 53 + VAT
(£ 62.28)

Comfort 800 Series (prices available on request)

- ◆ With optional gas dampened control action for users who like to change their seating position particularly slowly and gently.

Dimensions:	830	820	815
Seat depth	47cm	47cm	47cm
Adjustable seat depth	+/- 8cm		
Seat height	40-52cm		
Seat width	48cm	48cm	48cm
Height of backrest	75cm	55cm	39cm
Width of backrest	45cm	45cm	45cm
Adjustability of seat angle	+6 to -10 degrees		
Adjustability of back angle	+8 to -8 degrees		



Comfort RAB767
Tall back & R-type adjustable headrest
£ 543 + VAT
(£ 638.03)

Choose arms and add to price



Comfort RAB765
Medium back
£ 431 + VAT
(£ 506.43)

Choose arms and add to price



Comfort RAB760
Low back
£ 410 + VAT
(£ 481.75)

Choose arms and add to price

Spring-controlled 700 Series

- ◆ Particularly suitable if you are working in a confined space.
- ◆ All the support of a larger chair packed into a small, neat frame.
- ◆ Full support for the lower and upper back.
- ◆ Distinctly curved lower backrest fits snugly around user's lower back.
- ◆ Tapered upper backrest gives room for arms and elbows to move freely.
- ◆ An excellent chair for working in a small area at home, in a study bedroom or 'cubby-hole' office.



Five year guarantee in normal office use.
Recommended maximum user weight of 120Kg (approx 18.5 stone)

OPTIONAL FEATURES AVAILABLE



RAB4830
Multi-adjustable arms (height, depth, angle and width)
cost £ 71 + VAT
(£ 83.43)



RAB4851
Saturn arms
Height & width-adjustable
cost £ 64 + VAT
(£ 75.20)



RAB4801
Jupiter arms
Height & width-adjustable
cost £ 77 + VAT
(£ 90.48)



Inflatable lumbar support
£ 53 + VAT
(£ 62.28)

Dimensions:	767	765	760
Seat depth	49cm	46cm	46cm
Adjustable seat depth	+/- 6cm		
Seat height	40.5-52.5cm		
Seat width	48cm	46cm	46cm
Height of backrest	54cm	42cm	42cm
Width of backrest	47cm	45cm	45cm
Adjustability of seat angle	+6 to -10 degrees		
Adjustability of back angle	+8 to -8 degrees		

Synamics Chair



ALBSD1
High-back
£ 867 + VAT
(£ 1018.73)



ALBSD2
Medium-back
£ 867 + VAT
(£ 1018.73)



ALBSD3
Medium-back
with headrest)
£ 953.70 + VAT
(£ 1120.60)

Synamics (short for Spinal Dynamics) chairs have been developed by Albion Chairs and Steven Green, osteopath and former lecturer at The British School of Osteopathy.

These chairs incorporate a pelvic control system, comprising:

- ◆ A tilting seat, which, when angled forwards, encourages the pelvis to adopt a neutral position.
- ◆ A pelvic cushion, which gently holds the pelvis in place. The detachable cushion comes in three sizes or can be customised if required.

Additional features include:

- ◆ A two-way (height & depth) adjustable lumbar support.
- ◆ Mouldable 'memory' foam in the upper layers seat and back upholstery.
- ◆ A coccyx cut-out in the seat cushion
- ◆ Sliding seat depth
- ◆ Adjustable tension seat tilt action
- ◆ Optional adjustable headrest on the ALBSD3
- ◆ Two types of optional arm rest

FLOATING CHAIR

MULTI-SET CHAIR

POSTURE CHAIR

CUSTOMISED CHAIR



Click [HERE](#) (on this page in our online web catalogue to **DOWNLOAD PDF** of more Synamics chairs



The pelvic cushion

- easily removed from the chair (attached by studs).
- Sized small, medium and large
- Removable sipped cover
- Can be custom-shaped

Lets the coccyx 'float' over the cutaway.



Coccyx cut-out



Adjustable (height & depth) lumbar support



Upholstered arm tops



Multi-functional arm tops

Dimensions:

Seat cushion depth: 37 - 42 cm
Adjustable seat depth range: 5 cm
Seat height range: 55 - 61 cm
Seat width 49 cm
Seat angle: (+) 6.5 to (-)14.5 degrees
Back Height: (SD1) 69 cm; (SD2) 55 cm
Back width: 49 cm
Back height range: 5 cm
Adjustability of back angle 16 degrees

Suitability:

SD1 for 5'4" to 6'
SD2 below 5'4" to 5'10"
SD3 for 5' to 6'2"

Grahl Duo- Back chairs



The Grahl Type 11 Duo-back



Grahl Type 11 Duo-back

Chair with OPU arm rests

£ 455 + VAT (£534.62)



Standard Features

- ▶ Seat Height Adjustment
- ▶ Synchronous multi-lock tilting mechanism with easy reach weight tension control.
- ▶ Independently height adjustable back rest.
- ▶ Width adjustable duo-back® back rest pads.
- ▶ Sliding Seat mechanism.
- ▶ 43cm duo-back® back pads with polypropylene outer shells.
- ▶ 650mm 5-Star Base in Black

Arm Rest Options

OPU Height adjustable armrests with swivel and slide tops. **£105.00**

[Add VAT to these prices](#)

Optional Features

[Add VAT to these prices](#)

Soft Castors for hard floors	f.o.c
Energy Absorbing Seat Foam	£41.00
Height and depth adjustable neckrest	£216.00
Increased depth and increased height neckrest	£96.00
650mm Polished Aluminium base	£27.00

Standard Chair Measurements

Seat Height	45cm - 58cm
Seat Width	49cm
Seat Depth	45cm - 50cm
Back Height	48cm - 56cm
Back Width	40cm - 45cm
Seat - Lumbar	21cm - 29cm
Seat - Elbow	13cm - 25cm
Elbow - Elbow	52cm - 62cm



Print the PDF files from our web site....



Advance Seating Designs produce the most comprehensive ranges of specialist and custom-built back-care office chairs in the UK. Each range of Opera chairs can be tailor-made to suit all kinds of user needs. To view and/or print your own Advance Seating Designs PDF mini-brochures, chair comparison chart or complete price list, all you need to do is **CLICK** the appropriate links on this page in our [online catalogue](#). Therapists...by using this power links page on our website, you will have instant access to a massive Advance Seating Designs knowledge base. You can easily choose the most suitable chair for your clients **while** you are on-line, on-site at a client's workplace, or maybe later, when writing reports.



Opera 10 chairs



[Click HERE](#)
(on this page in our online web catalogue to [DOWNLOAD PDF](#))



Opera 20 chairs



[Click HERE](#)
(on this page in our online web catalogue to [DOWNLOAD PDF](#))



Wide (W) chairs

Opera 20W chairs



[Click HERE](#)
(on this page in our online web catalogue to [DOWNLOAD PDF](#))

FLOATING CHAIR

MULTI-SET CHAIR

POSTURE CHAIR



Opera 30 chairs



[Click HERE](#)
(on this page in our online web catalogue to [DOWNLOAD PDF](#))



Opera 60 chairs



[Click HERE](#)
(on this page in our online web catalogue to [DOWNLOAD PDF](#))



High (H) chairs

Opera 60H chairs



[Click HERE](#)
(on this page in our online web catalogue to [DOWNLOAD PDF](#))

CUSTOMISED CHAIR

EXTRA STRONG

24-7 CHAIR

Home Working



[Click HERE](#)
(on this page in our online web catalogue to [DOWNLOAD PDF](#))

Compare Opera Ranges



[Click HERE](#)
(on this page in our online web catalogue to [DOWNLOAD PDF](#))

Complete Opera Prices

Comfort Extras for Office Chairs



Gel arm top covers: Gel pads in an elasticated stretch-over cover. Great for making hard arm rests more comfortable.

Ref POS3523
£45 + VAT (**£ 52.88**)

A coccyx comfort cushion with combined backrest—unique.

Sitting for ages on the same spot? Tailbone growing sore? Strap a "Triple-C" cushion to your office chair.

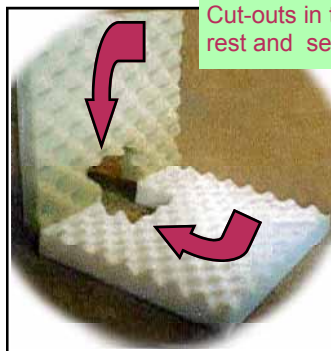

Cut-outs in the backrest and seat base.



Let a tender tailbone "float in space"



Comes in a dark blue jersey folding cover with carry handles

DIMENSIONS:-
Backrest:-
Height:- 14" (36 cm)
Width:- 16" (41 cm)
Depth of foam:- 2" (5 cm)

The "Triple-C"
Coccyx Comfort Cushion
£ 28 + VAT (**£ 32.90**)

(A waterproof cover is available for an extra £25 + VAT (£28.20))



The LumbarMate



Strap an inflatable LumbarMate to the back of an ordinary office chair for extra adjustable lumbar support in seconds. Can be used in cars, fork-lift trucks, drivers cabs and lounge furniture too.

The LumbarMate
£ 38 + VAT (**£ 44.65**)

Extra comfort foam overlay

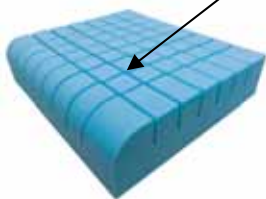

- ◆ Rounded front curve
- ◆ Slopes towards the back - helps prevent user sliding forward
- ◆ Castelated high-grade foam, helps with even weight distribution and air circulation
- ◆ Low to medium-risk pressure reduction
- ◆ Lightweight and durable
- ◆ Zipped polyester cover with carry handle
- ◆ Waterproof cover option (for same price)
- ◆ Two-year guarantee

Extra comfort foam overlay
£27.23 + VAT (**£32**)

Size:
Width 46 cm
Depth 40.5 cm
Height 7.5 cm

Visco-elastic 'memory' foam overlay



A slim visco-elastic 'memory' foam cushion to rest on top of an office chair, or any seat which feels too hard. Comes in a zipped polyester cover with carry handle.

Size:
Width 47.5 cm
Depth 48 cm
Height 3.8 cm

'Memory' foam overlay
£40.85 + VAT (**£48**)

Saddle Stools

The Salli Classic



Salli Classic (chrome)

- Choose leather, fabric or Ultra imitation leather
 - Chrome adjustable-height cylinder
 - Polished aluminium star-base
 - Adjustable seat tilt
 - Large 65mm easy-roll castors
- £279 + VAT (**£327.83**)

- Choose leather (16 colours)
- Fabric (4 colours)
- or Ultra imitation leather (black only)
- ESD-fabrics and
- ESD- leather
- [To see colour charts, visit the Salli stool buying area on our website](#)

The Salli Classic: User Tips

- ◆ Can be used by either sex, but should only be used all-day long by women.



Salli Classic (black finish)

- Choose leather, fabric or Ultra imitation leather
 - Black adjustable-height cylinder
 - Black aluminium star-base
 - Adjustable seat tilt
 - Large 65mm easy-roll castors
- £279 + VAT (**£327.83**)



Salli Classic (stainless steel)

- Choose leather, fabric or Ultra imitation leather
 - Stainless steel adjustable-height cylinder
 - Stainless steel aluminium star-base
 - Please note: stainless steel versions DO NOT have adjustable seat tilt.
 - Large 65mm easy-roll castors
- £412.61 + VAT (**£484.82**)

ACCESSORIES:

- ◆ Elbow table
- ◆ Foot rings
- ◆ Foot height control
- ◆ Backrests
- ◆ Tool trays
- ◆ Different castors
- ◆ Anti-static options
- ◆ [CD ROMS and full price lists on request](#)



Easy-clean Polyurethane tops for Salli Classic tops are available at no extra cost. Order by special request.
stannes@the-comfort-shop.co.uk



Saddle Stools The Salli Multi-adjuster



- Salli Multi-adjuster (chrome)
- Choose leather, fabric or Ultra imitation leather
 - Chrome adjustable-height cylinder
 - Polished aluminium star-base
 - Adjustable seat tilt
 - Large 65mm easy-roll castors
- £335 + VAT (**£393.63**)

The Salli Multi-adjuster offers unique width adjustment as well as a tilt option

The Salli Multi-adjuster: user tips.

- ♦ Can be used all day by either sex and offers unique width adjustment as well as the tilt option .



- Salli Multi-adjuster (black)
- Choose leather, fabric or Ultra imitation leather
 - Black adjustable-height cylinder
 - Black aluminium star-base
 - Adjustable seat tilt
 - Large 65mm easy-roll castors
- £335 + VAT (**£393.63**)



- Salli Twin with small elbow table
£485.54 + VAT **£570.51 inc VAT**
Salli Multi-adjuster with small elbow table
£540.54 + VAT **£635.13 inc VAT**
Small elbow table on its own
£206.54 + VAT (**£242.68**)



Length of curve 63cm
Top width 7cm, covered in matching leather upholstery.



Saddle Stools

Accessories



A backrest in leather to match seat
£60 + VAT (**£70.50**)

Adjustable-height pivoted pad follows back movements.

Can be locked or be left to move under light tension



A foot ring for high work surfaces
£35.75 + VAT (**£42.00**)

Ultra imitation leather (black only) is easily cleaned with soap and water or can be disinfected with ethyl alcohol (Duerr System Hygiene FD 312 solution)
Order by special request.
stannes@the-comfort-shop.co.uk



Foot-operated height control
£103.74 + VAT (**£121.90**)

For more advice on ESD (electrostatic discharge) seat fabrics, fittings and Anti-static castors
stannes@the-comfort-shop.co.uk



Small elbow table (for Twin or Multi-adjuster) in leather to match seat
£206.54 + VAT (**£242.68**)



Salli stools normally come with soft standard 65mm castors unless you specify otherwise. Other castors available include: small and large, hard or soft floor, braked, lockable, cleanable, industrial or anti-static. Order by special request.
stannes@the-comfort-shop.co.uk

Use the versatile Capisco either way round

- as an excellent 'chest support' chair
- or as a conventional office chair..



The distinctive backrest shape gives you good solid armrests either way you choose to sit.

The saddle seat also allows the greatest variation of posture. Choose a rectangular seat if you prefer.

Comfortable from desk height to semi-standing height.



Capisco 8106
£514 + VAT (**£603.95**)



Capisco 8107
with height-adjustable
& variable angle headrest
£607 + VAT (**£713.22**)

Who could use this chair?

- ◆ Physiotherapists
- ◆ Chiropodists
- ◆ Dentists
- ◆ Vets
- ◆ Artists
- ◆ Architects
- ◆ Tattooists
- ◆ Reflexologists
- ◆ Anyone who leans forward awkwardly towards their work for longer than they should! And could do with something to lean against.



Capisco 8105
Saddle seat only
(no backrest)
£204 + VAT
(**£239.7**)

- * Adjustable seat depth.
- * Lockable backwards tilt
- * Movement tension control
- * Choice of three heights
- * Foot ring option
- * Can have a Hag Step-Up swivelling footrest →



Foot ring £70 + VAT (**£82.25**)
Step-up footrest £72 + VAT (**£84.60**)

Standard seat height range (8106 & 8107): 48.5-66 cm
Optional seat height ranges at no extra cost are:
Low gas lift (41-55 cm) or High gas lift (57-81 cm)

Dimensions (8106 & 8107)

Adjustable Seat depth:	37-46 cm
Seat width:	49 cm
Back pad total height	44 cm
Height of most prominent part of backrest (measured from top of seat cushion)	17-26 cm

Saddle Stools

The RH Support Stools



Dubbed 'the chiropodists, favourite', this Rh Support Stool with its unique back-rest, can be sat on back-to-front to support the chest or sternum if you need to work leaning forward, or it can be perched on in the conventional way.

The 'chiropodists' favourite' can be set very low when required and is light enough to lift in and out the car and carry on home visits.



RH Support 4545 with unique Alternative 'chest support' back
 £264 + VAT (**£310.20**)



A foot ring for high work surfaces
 £43 + VAT (**£50.52**)



Support 4521
 £252 + VAT
 (**£296.10**)



Support 4511
 £254 + VAT
 (**£298.45**)



Support 4501
 £260 + VAT
 (**£305.50**)



Support 4532
 £188 + VAT
 (**£220.90**)

Five gas stem heights: **standard 4A (62-87 cm)**; 4C (55-74cm); 4FH (50-65cm); 4F (40-53cm) & 4FL (39-48cm).
 Stools come with **glide feet as standard**. Chose optional hard floor or soft floor castors (no extra charge)

THE ASD Sport-Sit Stool



The Sport-sit
 £ 307 + VAT (**£360.73**)
Add
 £ 56 + VAT (**£ 65.80**)
For AMP1X arms



ASD Sport-sit

- ◆ Versatile sit-stand chair
- ◆ Holds spine in neutral position when hands and body are forced to lean forward to perform a task.
- ◆ Body weight passes through spine and into the feet giving greater freedom of movement to upper body and less strain on lower back
- ◆ Used by: bank cashiers, production workers, hairdressers, dentists, laboratory technicians etc.

The ASD Sport-sit

Backs

Height-adjustable (range 15-23cm).
 Angle (minus 5 forwards to 20 degrees backwards).
Small back (SPS3) shaped for pelvic support.
Full back (SPS7) [illustrated] supports upper back.
Sternum support (SPS5) Use conventionally or sit with pad on chest, with top supporting lowest rib.

Seat

Unique shaping holds pelvis when tilted forwards.
 Tilt (minus 8 forwards to 10 degrees backwards).

Arms

Optional (AMP1X) fully-adjustable with swivel-tops.

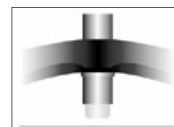

ASD Sport-sits have a **movement-stop** gas stem for extra safety when working with a seat height above 65cm. When seat is raised above 65cm, a big rubber stopper is released from the bottom of the gas cylinder and it locks against the floor. Lower the seat below 65cm and the stopper retracts again.

Industrial Task Stools and Chairs

Polyurethane seating

Choosing the right furniture for industrial applications can be a fairly detailed procedure. Ask to see our sales representative, who will bring up-to-date literature and arrange to supply you with some samples to try on-site



Minotaur PS9608
Task Chair
£ 98.37 + VAT
(£115.59)



Minotaur work stool
PS9641
£ 80 + VAT **(£ 94)**



Minotaur PS9637
draughtsmans chair
£ 125 + VAT
(£146.88)

Height-adjustable arms for Minotaur chairs
& stools £ 34 + VAT (£ 39.95)



A



Phone us about
prices for this
type of chair.

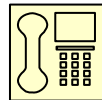

B



C



D



E

Desks and desktop accessories - Useful Tips

Put simply, you should never let your desk arrangements dictate how you work or sit. Whether you are at home, in the office or sharing a desk, always arrange your working area to suit you. This sounds like common sense, but many people tend to neglect basic comfort principles.

Ideas such as:

- ◆ A desk or workstation should give the user a comfortable height and position to work at.
- ◆ Keep work and frequently-used desktop equipment within easy reach.
- ◆ No awkward stretching, twisting, lifting or leaning at the desk or elsewhere.
- ◆ Desk and seat heights should be set so working by hand is best done at elbow level.
- ◆ Avoid work surfaces thicker than 30mm or work places which obstruct a user's legs.
- ◆ Desks need to be deeper nowadays to provide room for computers, screens *and workers*.
- ◆ Adjustable-height desks are ideal for people of differing heights who share a desk.
- ◆ Hand or forearm support may be required for tasks using close hand-eye coordination.

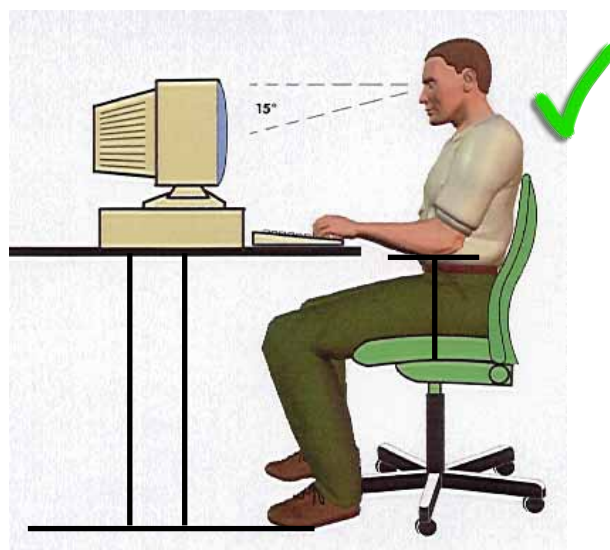

Don't hesitate to adjust your chair, desk accessories and desk (if you can) to suit whatever task you need to perform. If you can vary your tasks every so often, so much the better. Try to keep your workspace tidy.

- ◆ Most keyboards have fold-down feet to adjust them for tilt.
- ◆ Keep your elbows in and your mouse close to you. Avoid over-stretching.
- ◆ A combined mouse pad and wrist rest is surprisingly comfortable.

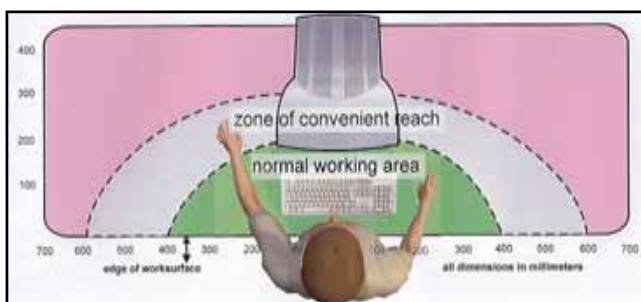

- ◆ Look away from the screen towards infinity once in a while.
- ◆ Take all your official breaks. Or ask for some.
- ◆ Avoid glare, use blinds or screen filters and insist on good lighting.

Multi-user workstations:

- ◆ Desk height may need to be height-adjustable for sit/stand usage.
- ◆ Chair seat depth may need to be adjustable in order to suit each user.
- ◆ Adjustable back height and lumbar support on chairs may also be very useful.
- ◆ Chair arms should have adjustable height, width, depth and even swivel top options.
- ◆ A chair must legally support the heaviest of the multi-users
- ◆ Computer screen height, size and definition should be adjustable and acceptable to all users

Desks: electric height-adjustable



ConSet Range 501-17

A low-price electric height-adjustable desk

- ◆ Five choices of desk top shape.
- ◆ Different desk top sizes
- ◆ Two frame widths to choose from

Special Notes

- Height range = 680mm to 1200mm
- Cable Tidy = Wires for PC etc.. can be placed in the flip down tray under the desk
- Frame lifting capacity = 80kg
- Frame colour = Silver RAL 9006
- Wheels = castors on front for easy repositioning in your office with 1 leveller on each leg
- Special tops and shapes = up to 2000mm x 1000mm, minimum depth 720mm



[Click HERE](#) on *this* page in our [online catalogue](#), when you visit our website, for the full range of ConSet electric desks, desk tops, pedestals and all other desk accessories.

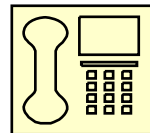

Buying desks, desk tops, pedestals and accessories can be a bit tricky. Just give us a quick ring for a helpful answer to your questions.



	Series	Height range (cm)	Speed (mm/sec)	Lifting capacity of frame (kg)	Frame weight boxed (kg)		501-1795096	501-1795156	Frame Colour SILVER
	501-17	66-118	25	80	28	Add VAT to all prices			Frame only
					31				£ 341
									£ 347

See next two pages for choice of **desk tops**. Look for the tops coded with a blue square. For the best budget price, choose a Beech / Melamine combination. Then add the **frame price** to **desktop** price for total to pay. **Add VAT to all prices**

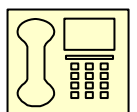
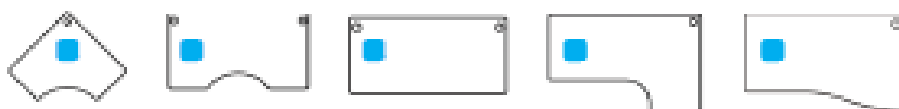

Desk & Meeting Table tops

Add VAT to all prices

- 501-11
- 501-17
- 501-7
- 501-19
- 501-23

Table tops

	Beech			Maple			Oak			Beech			Maple			Oak		
	Veneer			Veneer			Veneer			Veneer			Veneer			Veneer		
	Melam lte			Melam lte			Melam lte			Melam lte			Melam lte			Melam lte		
117H 	86	114	114	200C	149	169	169	200R	155	183	183							
	67	67	67	100	103	103	80	118	118	18								
120H 	126	146	146	100S	86	101	101	160R+040-60S	183	206	206							
	93	93	93	80	63	63	80	132	132	132								
138H 	86	117	117	120-80S	98	110	110	180R2+040-60S	198	226	226							
	69	69	69	60	68	68	80	143	143	143								
140H 	110	124	124	160-80S	123	140	140	160L	138	157	157							
	78	78	78	80	87	87	120	103	103	103								
100C 	86	114	114	180-80S	142	161	161	180L2	153	177	177							
	67	67	67	80	102	102	120	114	114	114								
120C 	98	110	110	200-80S	149	169	169	200L	155	183	183							
	68	68	68	80	103	103	120	118	118	118								
160C 	123	140	140	160R	138	157	157	160L+040-60S	183	206	206							
	87	87	87	80	103	103	100	132	132	132								
180C 	142	161	161	180R2	153	177	177	180L2+040-60S	198	226	226							
	102	102	102	80	114	114	160	143	143	143								

Table tops

- 501-11
- 501-17
- 501-7
- 501-19
- 501-23

	Beech		Maple		Oak			Beech		Maple		Oak	
	Veneer	Melamine	Veneer	Melamine	Veneer	Melamine		Veneer	Melamine	Veneer	Melamine	Veneer	Melamine
080-60S							120LW ■■■						
	68	44	75	44	75	44		98	68	110	68	110	68
120-60S ■							140LW ■■■						
	102	67	113	67	113	67		111	78	125	78	125	78
120RW ■■■							160LW ■■■						
	98	68	110	68	110	68		138	103	157	103	157	103
140RW ■■■							180LW ■■■						
	111	78	125	78	125	78		153	114	177	114	177	114
160RW ■■■							200LW ■■■						
	138	103	157	103	157	103		155	118	183	118	183	118
180RW ■■■							180E ■						
	153	114	177	114	177	114		153	114	177	114	177	114
200RW ■■■							2x100K ■						
	155	118	183	118	183	118		230	146	256	146	256	146



Add VAT to all prices



	CPU-holder 400-3	22
	Penn-drawer/swing tray 440-1	27
	Cable tray for 501-11 C116 C156 C196	39 43 48
	Mobile pedestal, beech 3 drawers PED 3A400 B	149
	Mobile pedestal, maple 3 drawers PED 3A400 M	149
	Mobile pedestal, beech 4 drawers PED 4A400 B	161
	Mobile pedestal, maple 4 drawers PED 4A400 M	161
	Mobile pedestal on wheels in metal, 2 drawers, silver with black drawers BOX1	180
	Mobile pedestal on wheels in steel, 2 drawers plus box for ring binders, silver with black drawers BOX2	255
	Mobile pedestal on wheels in steel, 2 drawers plus 3 boxes for ring binders, silver with black drawers BOX4	405

[Click HERE](#) on this page in our online catalogue, when you visit our website, for the full range of ConSet electric desks, desk tops, pedestals and all other desk accessories.

These pages are just a small snapshot of the desks we can supply. Just give us a call to discuss the full range and ask to see our rep'.

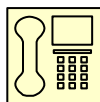
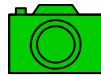

Maple Melamine

Beech Melamine

Silver RAL 9006



Print the PDF file from our web site....

C.S.ERGONOMICS

17, Alexandria Drive,
St Annes, Lancashire, FY8 1JF.
www.the-comfort-shop.co.uk

(01253) 724902

THE COMFORT SHOP

Desks: crank height-adjustable

D3K MANUAL HEIGHT ADJUSTABLE - DESKING

Widely used in I.T. Suites, Libraries, Control Centres and Drop-in areas. Height range 680 - 930mm suit most users needs and is easily adjusted via a retractable handle. Welded frame construction gives extra strength and rigidity.



Print the PDF file from our web site....



Click [HERE](#) (on this page in our online web catalogue for more details)



PRODUCT	GRAIN DIRECTION	CODE	A x B x C x D	GROUP 1	GROUP 2	GROUP 3
RECTANGULAR						

Add VAT to all prices

Can be used with under desk or desk high pedestals.



GDSH18Z	1800 x 800	534.00	546.00	561.00
GDSH16Z	1600 x 800	496.00	507.00	520.00
GDSH14Z	1400 x 800	482.00	491.00	504.00
GDSH12Z	1200 x 800	471.00	482.00	492.00
GDSH10Z	1000 x 800	466.00	474.00	485.00
GDSH08Z	800 x 800	459.00	469.00	480.00

WAVE

Can be used with under desk or desk high pedestals.



GDWHR18Z	1800 x 800 x 1000	571.00	586.00	602.00
GDWHR16Z	1600 x 800 x 1000	533.00	546.00	560.00
GDWHR14Z	1400 x 800 x 1000	519.00	532.00	544.00
GDWHR12Z	1200 x 800 x 1000	508.00	520.00	534.00
GDWHL18Z	1800 x 800 x 1000	571.00	586.00	602.00
GDWHL16Z	1600 x 800 x 1000	533.00	546.00	560.00
GDWHL14Z	1400 x 800 x 1000	519.00	532.00	544.00
GDWHL12Z	1200 x 800 x 1000	508.00	520.00	534.00

DOUBLE WAVE

Can be used with under desk or desk high pedestals.

Add VAT to all prices



GDWHD18Z	1800 x 800 x 1000	571.00	586.00	602.00
GDWHD16Z	1600 x 800 x 1000	533.00	546.00	560.00

INFORMATION

←→ GRAIN DIRECTION - Top panel GROUP 1 - Royal Oak GROUP 2 - Beech, Grey or Walnut GROUP 3 - Apple, Maple, Pastels or White



C.S.ERGONOMICS

17, Alexandria Drive,
St Annes, Lancashire, FY8 1JF.
www.the-comfort-shop.co.uk

(01253) 724902

THE COMFORT SHOP

DESQ HEIGHT ADJUSTABLE - DESKING

DesQ height adjustable desking can be set between 727 - 847mm high using adjustable legs that should be pre-set before use. The legs are available in both static and mobile options.



Adjustable in 20mm increments.

PRODUCT	GRAIN DIRECTION	CODE	A x B x C x D	GROUP 1	GROUP 2	GROUP 3
RECTANGULAR DESKING						
Add VAT to all prices						



QDS18Z/QLA4	1800 x 800	268.00	278.00	289.00
QDS16Z/QLA4	1600 x 800	245.00	254.00	264.00
QDS14Z/QLA4	1400 x 800	239.00	246.00	256.00
QDS12Z/QLA4	1200 x 800	233.00	241.00	251.00
QDS10Z/QLA4	1000 x 800	227.00	236.00	244.00
QDS08Z/QLA4	800 x 800	222.00	230.00	238.00

WAVE DESKING



Right hand

GDWSR18Z/QLA4	1800 x 800 x 1000	302.00	314.00	327.00
GDWSR16Z/QLA4	1600 x 800 x 1000	279.00	290.00	302.00
GDWSR14Z/QLA4	1400 x 800 x 1000	273.00	284.00	295.00
GDWSR12Z/QLA4	1200 x 800 x 1000	266.00	277.00	288.00
GDWSR10Z/QLA4	1000 x 800 x 1000	261.00	271.00	282.00



Left hand

GDWSL18Z/QLA4	1800 x 800 x 1000	302.00	314.00	327.00
GDWSL16Z/QLA4	1600 x 800 x 1000	279.00	290.00	302.00
GDWSL14Z/QLA4	1400 x 800 x 1000	273.00	284.00	295.00
GDWSL12Z/QLA4	1200 x 800 x 1000	266.00	277.00	288.00
GDWSL10Z/QLA4	1000 x 800 x 1000	261.00	271.00	282.00

DOUBLE WAVE DESKING



QDWD18Z/QLA4	1800 x 800 x 1000	302.00	314.00	327.00
QDWD16Z/QLA4	1600 x 800 x 1000	279.00	290.00	302.00

Add VAT to all prices

UNIVERSAL WORKSTATION



Right hand

QWUR18Z/QLA4	1800 x 800 x 600 x 1200	326.00	337.00	352.00
QWUR16Z/QLA4	1600 x 800 x 600 x 1200	303.00	315.00	328.00
QWUR14Z/QLA4	1400 x 800 x 600 x 1200	293.00	304.00	317.00



Left hand

QWUL18Z/QLA4	1800 x 800 x 600 x 1200	326.00	337.00	352.00
QWUL16Z/QLA4	1600 x 800 x 600 x 1200	303.00	315.00	328.00
QWUL14Z/QLA4	1400 x 800 x 600 x 1200	293.00	304.00	317.00

DESQ - DESKS & WORKSTATIONS

DesQ are flat packed desks and workstations with 25mm tops. Overall height = 727mm. Metalwork available in Black, Grey or Silver - please specify when ordering. All desk prices are specified with fixed height legs with leveler.

Desks: Basic fixed-height



DESQ - DESKS & WORKSTATIONS

DesQ are flat packed desks and workstations with 25mm tops. Overall height = 727mm. Metalwork available in Black, Grey or Silver - please specify when ordering. All desk prices are specified with fixed height legs with leveller.

DESQ DESKING

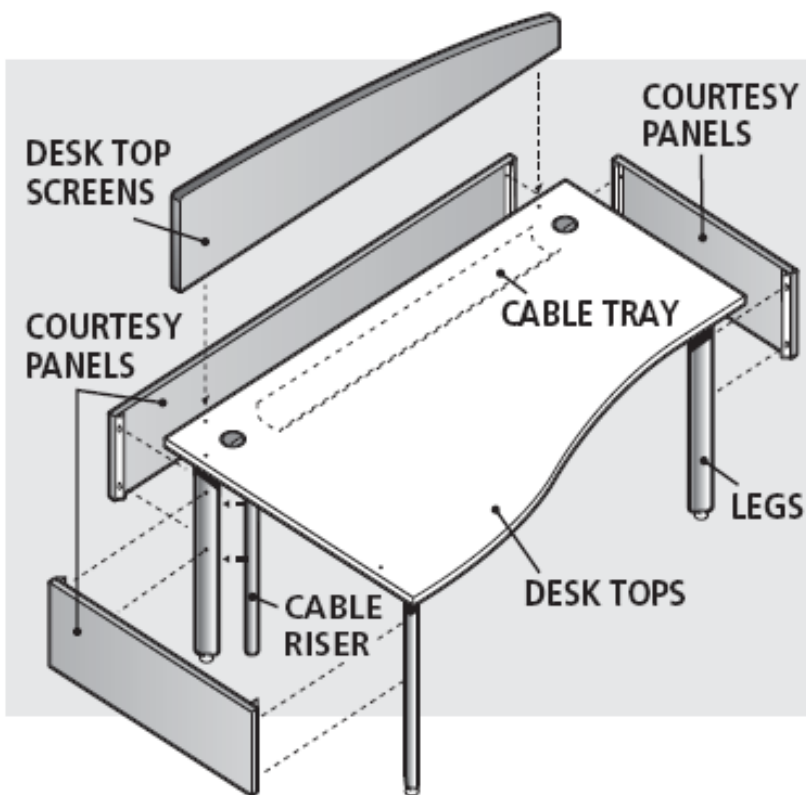

BASIC FORM:

Consists of a work surface and leg structure with features such as courtesy panels, cable management and desk top screens added to meet individual requirements.

Care should be taken when ordering to ensure that all required items are specified; each item has a unique model number to assist this ordering process.

All DesQ desks and pedestals are free-standing so room layouts can easily be reconfigured.



[Click HERE](#)

(on this page in our online web catalogue for more details)

DESK TOPS:

All DesQ furniture has 25mm tops finished with 3mm high impact resistant polypropylene edging. A selection of M.F.C board finishes are available, priced according to Group 1, 2 & 3.

LEGS FIXED HEIGHT WITH LEVELLER FITTED AS STANDARD:

(Unless specified, fixed height legs with leveller are fitted as standard, giving an overall height of 727mm. Fixed height legs for 650 & 680mm are offered as options).

Alternative legs at an additional cost.

1. Adjustable height leg with leveller.
2. Fixed height leg with castor.
3. Adjustable height leg with castor.

Adjustable height legs facilitate desk height range from 727 to 847mm in 20mm increments.

METAL COMPONENT COLOURS:

Steel sub frames, legs, courtesy panels and desk top screens are available as standard in Black (RAL 9005), Grey (RAL 7024) or Silver (RAL 9006). Specify required colour when ordering.

DESK TOP SCREENS:

Straight or wave desk top screens in perforated steel or fabric can be fitted to the back of all desks and the long side on wave desks, workstations and corner unit.

COURTESY PANELS:

Courtesy panels in wood or perforated steel can be fitted to back and/or sides.

CABLE MANAGEMENT:

Cable riser locates to leg to run cables vertically. Cable tray hangs on inside of subframe to run cables horizontally.

DESQ - DESKS & WORKSTATIONS

DesQ are flat packed desks and workstations with 25mm tops. Overall height = 727mm. Metalwork available in Black, Grey or Silver - please specify when ordering.

PRODUCT **GRAIN DIRECTION** **CODE** **A** x **B** x **C** x **D** **GROUP 1** **GROUP 2** **GROUP 3**

RECTANGULAR DESKING



QDS18Z	1800	x	800					208.00	218.00	229.00
QDS16Z	1600	x	800					185.00	194.00	204.00
QDS14Z	1400	x	800					179.00	186.00	196.00
QDS12Z	1200	x	800					173.00	181.00	191.00
QDS10Z	1000	x	800					167.00	176.00	184.00
QDS08Z	800	x	800					162.00	170.00	178.00

WAVE DESKING



Right hand

QDWSR18Z	1800	x	800	x	1000			242.00	254.00	267.00
QDWSR16Z	1600	x	800	x	1000			219.00	230.00	242.00
QDWSR14Z	1400	x	800	x	1000			213.00	224.00	235.00
QDWSR12Z	1200	x	800	x	1000			206.00	217.00	228.00
QDWSR10Z	1000	x	800	x	1000			201.00	211.00	222.00



Left hand

QDWSL18Z	1800	x	800	x	1000			242.00	254.00	267.00
QDWSL16Z	1600	x	800	x	1000			219.00	230.00	242.00
QDWSL14Z	1400	x	800	x	1000			213.00	224.00	235.00
QDWSL12Z	1200	x	800	x	1000			206.00	217.00	228.00
QDWSL10Z	1000	x	800	x	1000			201.00	211.00	222.00

DOUBLE WAVE DESKING

Add VAT to all prices



QDWD18Z	1800	x	800	x	1000			242.00	254.00	267.00
QDWD16Z	1600	x	800	x	1000			219.00	230.00	242.00

UNIVERSAL WORKSTATION



Right hand

QWUR18Z	1800	x	800	x	600	x	1200	266.00	277.00	292.00
QWUR16Z	1600	x	800	x	600	x	1200	243.00	255.00	268.00
QWUR14Z	1400	x	800	x	600	x	1200	233.00	244.00	257.00



Left hand

QWUL18Z	1800	x	800	x	600	x	1200	266.00	277.00	292.00
QWUL16Z	1600	x	800	x	600	x	1200	243.00	255.00	268.00
QWUL14Z	1400	x	800	x	600	x	1200	233.00	244.00	257.00

120° ANGULAR DESKING



QDY12Z	1200	x	800	x	800	x	1200	302.00	318.00	334.00
QDY10Z	1000	x	600	x	600	x	1000	287.00	302.00	317.00

CORNER UNITS

Add VAT to all prices



QCU16Z	1600	x	800	x	800	x	1600	340.00	358.00	378.00
QCU14Z	1400	x	800	x	800	x	1400	324.00	340.00	358.00
QCU12Z	1200	x	800	x	800	x	1200	280.00	294.00	308.00

DESQ - CABLE TRAYS, CABLE RISER & CPU HOLDER

PRODUCT **CODE** **FOR USE WITH** **PRICE**

CABLE TRAYS - LOCATES TO INSIDE OF UNDER FRAME AT REAR



QCT18	For 1800 wide desks	37.00
QCT16	For 1600 wide desks	35.00
QCT14	For 1400 wide desks	34.00
QCT12	For 1200 wide desks	33.00
QCTA12	For 1200° desks	33.00
QCT10	For 1000 wide desks	33.00
QCTA10	For 1000° desks	33.00
QCT08	For 800 wide desks	32.00
QCT06	For 600 wide desks	32.00

C.S.ERGONOMICS

17, Alexandria Drive,
St Annes, Lancashire, FY8 1JF.
www.the-comfort-shop.co.uk

(01253) 724902

THE COMFORT SHOP

DESQ - COURTESY PANELS

Metalwork available in Black, Grey or Silver, please specify when ordering.

Add VAT to all prices

PRODUCT	GRAIN DIRECTION	CODE	DESCRIPTION	TO SUIT DESK	GROUP 1	GROUP 2	GROUP 3
WOODEN COURTESY PANELS							
		QCPW18	Standard depth	1800	37.00	39.00	42.00
		QCPW16	Standard depth	1600	32.00	34.00	35.00
		QCPW14	Standard depth	1400	29.00	31.00	33.00
		QCPW12	Standard depth	1200	27.00	28.00	30.00
		QCPW10	Standard depth	1000	25.00	26.00	28.00
		QCPW08	Standard depth	800	23.00	24.00	25.00
		QCPW06	Standard depth	600	22.00	23.00	24.00
		QCPWA12	For 1200 angular desk	1040	25.00	27.00	28.00
		QCPWA10	For 1000 angular desk	840	24.00	25.00	27.00

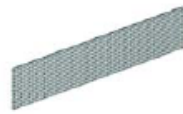
PRODUCT	GRAIN DIRECTION	CODE	DESCRIPTION	TO SUIT DESK	GROUP 1	GROUP 2	GROUP 3
PERFORATED STEEL COURTESY PANELS							
		QCPS18	Standard depth	1800	Black, Grey or Silver		134.00
		QCPS16	Standard depth	1600	Black, Grey or Silver		128.00
		QCPS14	Standard depth	1400	Black, Grey or Silver		127.00
		QCPS12	Standard depth	1200	Black, Grey or Silver		111.00
		QCPS10	Standard depth	1000	Black, Grey or Silver		102.00
		QCPS08	Standard depth	800	Black, Grey or Silver		92.00
		QCPS06	Standard depth	600	Black, Grey or Silver		84.00
		QCPSA12	For 1200 angular desk	1040	Black, Grey or Silver		105.00
		QCPSA10	For 1000 angular desk	840	Black, Grey or Silver		95.00

DESQ - DESKTOP SCREENS

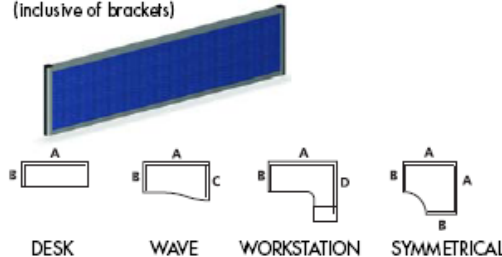

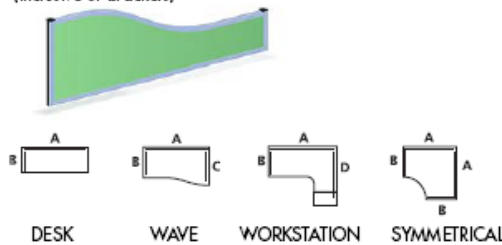
PRODUCT	CODE	WHERE USED	W x H	BAND 1	BAND 2
380mm HIGH DESKTOP SCREENS - STRAIGHT					
(inclusive of brackets)					
	VSDF184-04	1800 (A)	1768 x 380	174.00	183.00
	VSDF174-04	1200 (D)	1598 x 380	135.00	143.00
	VSDF164-04	1600 (A)	1568 x 380	134.00	142.00
	VSDF144-04	1400 (A)	1368 x 380	114.00	122.00
	VSDF124-04	1200 (A)	1168 x 380	109.00	117.00
	VSDF104-10	1000 (C)	968 x 380	105.00	112.00
	VSDF104-04	1000 (A)	968 x 380	105.00	112.00
	VSDF084-10	800 (B)	768 x 380	96.00	100.00
	VSDF084-04	800 (A)	768 x 380	96.00	100.00

PRODUCT	CODE	WHERE USED	W x H	BAND 1	BAND 2
380/180mm HIGH DESKTOP SCREENS - WAVE					
(inclusive of brackets)					
	VSDF184W-04	1800 (A)	1768 x 380/180	201.00	212.00
	VSDF174W-04	1200 (D)	1598 x 380/180	173.00	180.00
	VSDF164W-04	1600 (A)	1568 x 380/180	172.00	179.00
	VSDF144W-04	1400 (A)	1368 x 380/180	167.00	175.00
	VSDF124W-04	1200 (A)	1168 x 380/180	159.00	166.00
	VSDF104W-10	1000 (C)	968 x 380/180	154.00	162.00
	VSDF104W-04	1000 (A)	968 x 380/180	154.00	162.00
	VSDF084W-10	800 (B)	768 x 380/180	135.00	140.00
	VSDF084W-04	800 (A)	768 x 380/180	135.00	140.00

DESQ - LINK POST SEATS

Metalwork available in Black, Grey or Silver - please specify when ordering.

Add VAT to all prices

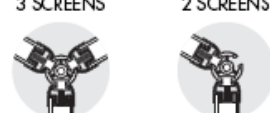
PRODUCT	CODE	DESCRIPTION	PRICE
380mm HIGH 4 WAY LINK POST SET - PLEASE SPECIFY PAINT COLOUR - BLACK, GREY OR SILVER			
		4 WAY LINKING 4 SCREENS	
		4 WAY LINKING 3 SCREENS	
		4 WAY LINKING 2 SCREENS	
		4 WAY LINKING STRAIGHT	
VLP04			27.00
380mm HIGH 3 WAY LINK POST SET - PLEASE SPECIFY PAINT COLOUR - BLACK, GREY OR SILVER			
		3 WAY LINKING 3 SCREENS	
		3 WAY LINKING 2 SCREENS	
VLP04-3			23.00

Metal Corner Desk Extender

Before you embark on a costly decision to buy new desks, try this desk extender first.

Made exclusively for C.S. Ergonomics, the office back care division of The Comfort Shop Ltd.

Double the working space at a corner desk with this unique desk extender. When office chair arms jam against the edges of a corner desk and force the user to lean too far forward for comfort, it is time to use a desk extender. Made of smooth, black powder-coated steel, this desk extender or corner keyboard shelf as they are sometimes known, will make a huge difference to desktop ergonomics, general posture and comfort.

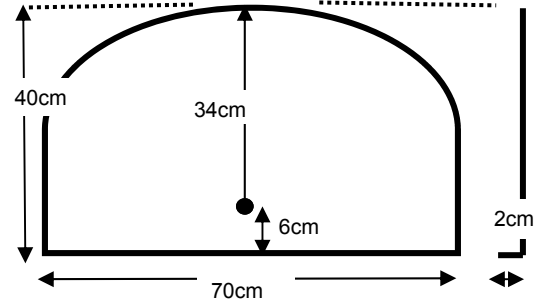

Steel:
Weight: 2.25 Kg
Thickness: 1mm
Colour: black
Finish: Powder-coated

Ref: COMCKS1
£25.00 + VAT
(£29.38)



This desk extender works very well with the Flexdesk on page 62



Monitor arms



We supply many types of monitor arm. Just ask us for details and advice. To keep things simple, these work well and are easy to fit.

- ◆ Adjustable for height, viewing angle, distance and tilt
- ◆ Aluminium and anthracite plastic finish
- ◆ Desk 'G' clamp standard. Through desk fitting on request.
- ◆ Maximum load 10 Kgs
- ◆ VESA 75 x 75 / 100 x 100 mm screen mount.

Screenmate LCD arm

Ref: SCRSCRMAT1
£67.23 + VAT
(£79)

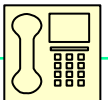

- ◆ Fully adjustable for height, viewing angle, distance and tilt
- ◆ Suits a wide range of LCD screen sizes from 36-56cm
- ◆ TUV / GS approved
- ◆ Desk clamp fitting only for worktops up to 6cm
- ◆ Maximum load 10 Kgs
- ◆ VESA 75 x 75 / 100 x 100 mm screen mount.

Classic articulated LCD arm

Ref: OSMO52212
£62 + VAT
(£72.85)

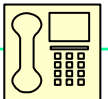

Viewmaster LCD Arm

- ◆ 4 pivoting points
- ◆ Smooth stepless height adjustment
- ◆ VESA 75 / 100 mm screen mounts
- ◆ Desk clamp depth up to 55mm



Viewmaster Articulated LCD Arm

- ◆ 5 pivoting points
- ◆ Height and depth adjustable 150-540mm
- ◆ Rotates 360, tilts 145 & swivels 145 deg.
- ◆ Neat cable management design
- ◆ Desk clamp up to 50 mm

Ref: OSMO53102
£148.94 + VAT **(£175)**

Supplied with **both** desk clamp and desk hole mounts. Maximum screen weight **12 Kgs**

Ref: OSMO53202
£168.51 + VAT **(£198)**

Posture blocks or screen raisers



Le Bloc 1
(2.5 cm high)
£4.95 + VAT each
(£5.81)

Le Bloc 2
(5 cm high)
£9.95 + VAT each
(£11.69)



DIMENSIONS:
Le Bloc 1
Height:- 2.5 cm
Width:- 29 cm
Depth:- 29 cm



DIMENSIONS:
Le Bloc 2
Height:- 5 cm
Width:- 29 cm
Depth:- 29 cm



Le Bloc FS
(6.5 cm high
but **only 22 cm deep** from
front to back)
Raises flat screens and
provides extra storage
space as well.
£11.50 + VAT each
(£13.51)

Le Bloc monitor stands come in three heights:
Le Bloc 1 (2.5 cm); **Le Bloc 2** (5 cm) & **Le Bloc FS** (6.5 cm).
Types 1 & 2 interlock and can be combined to achieve
the desired screen height. The FS is just for flat LCD screens

Special cut-outs allow
neat cable management

Foot rests

Any worker who cannot place their feet flat on the floor once their chair and desk have been set up to the correct working height, should try a foot rest - the more adjustable the better. An ideal foot rest should be height-adjustable and be able to tilt as well. Foot rests can also be used for therapeutic purposes, to ease pressure on back of the thighs and help with circulation or exercising the feet and ankles.

The Comfort Tread Foot rest



Tilted by foot pressure.
Foot massage bumps.
£25.95 + VAT (**£30.49**)

DIMENSIONS:
Tilt angle: (+) or (-) 15 degrees
Plate width: 45 cm
Depth: 33 cm



The Comfort Tread
adjustable-height foot rest.
£39.95 + VAT (**£46.94**)

DIMENSIONS:
Tilt angle: (+) or (-) 15 degrees
Height ranges: 10, 14 & 17 cm
Plate width: 46 cm
Depth: 35 cm



The Quickstep
Tilting foot rest good for
keeping restless feet on
the move
£80 + VAT (**£94**)

SIZE: width:43 cm; depth: 33 cm & height: 12 cm



CSE-952 foot rest
Height and tilt adjustable, triggered and
set by user's feet.
£105 + VAT (**£124.37**)

DIMENSIONS:
Height range: 3-15 "



**Bexhill rocker
leg / foot rest**
Brown vinyl, brown metal legs
Ref: SNH4210
£82.34 + VAT (**£96.75**)
Beige dralon, brown metal
legs Ref: SNH4212
£97.83 + VAT (**£114.95**)

DIMENSIONS:
Foot cushion: 30 x 30 cm
Calf cushion: 41 x 30 cm
Rocker length: 48 cm



£93.62 + VAT
(**£110**)

Adjustable height & tilt leg rest

- ◆ For a single leg (seated)
- ◆ Adjustable height 30-45 cm
- ◆ Cushion 51 x 30 cm
- ◆ Easy-clean vinyl
- ◆ Non-slip rubber feet or castors for the same price



**BASIC
foot rest**
Ref: DAT96500
tilted by user's
feet
£29.50 + VAT
(**£34.66**)

DIMENSIONS:
W width: 47.5 cm; depth: 30 cm; Tilt: 7-13 cm



The Discus one-touch
height-adjustable foot rest.
From 5-15 cm
£99.58 + VAT (**£117**)



Ref: CSELEG1

Medical leg rest

- ◆ For a single leg (seated)
- ◆ Adjustable height
- ◆ Adjustable angle
- ◆ Easy-clean leatherette
- ◆ For sitting heights 41—54 cm

£174.47 + VAT (**£205**)

Writing slopes & document holders

The FlexDesk



The new **FlexDesk 630** is one of the cleverest desktop read-write slopes in use today.

It effectively doubles your desk space, You can use it as an in-line document holder, reading slope, writing slope and keyboard store.

It enables you to do several tasks on your workspace at the same time be effectively **doubling your central desk space area.**

The FlexDesk is efficient and ergonomically useful. A 'must' for many workstations.

Size: Width 51 cm; Depth 36 cm
Height-adjustable back range 11.5-17.5 cm



Pull it towards you and use it as a book and reading rest



Use it as a writing slope



Push away from you and it is a document holder



Winner of the FIRA Ergonomic Excellence Award 2007

The FlexDesk 630 (ERGOFLXDSK)

£98.73 + VAT (**£116**)

- **generous discounts available for multiple orders** -

The A3 & A4 Jotters



Size: **A4**

31 cm deep x 21 cm wide x 14.5 cm high

£38.30 + VAT (**£45**)

Size: **A3**

31 cm deep x 43 cm wide x 15.5 cm high

£43.40 + VAT (**£51**)

The Lap Riser



Comes with carry handle and Super-glide wrist support

Size: 37cm wide x 35.5cm deep x 14.5 cm high
Weight: 1 Kg (2.2lbs)
£58.73 + VAT (**£69**)

Clear acrylic, portable fixed height writing slopes



Standard size

Ref 1051

£27.95 + vat (**£32.84**)

- Good for those working in a confined space
- Non reflective frosted effect acrylic, to avoid glare
- Does not show finger marks
- Front ledge overhangs desk to prevent sliding
- Ledge at the top to store pens
- 34.5cm wide x 40cm deep x 10cm high



42cm wide x 40cm deep x 10cm high

Large size

Ref 1052

£29.95 + vat (**£35.19**)

28 cm wide



Clip-on document holder

Ref 1053

£18.95 + vat

(**£22.27**)

C.S.ERGONOMICS

17, Alexandria Drive,
St Annes, Lancashire, FY8 1JF.
www.the-comfort-shop.co.uk

(01253) 724902

THE COMFORT SHOP

Writing Slopes

A simple rule-of-thumb is: 'the closer your reading or written work is to your face, the less you lean towards it and risk straining your neck and upper back.'

The Putnam Writing Slope



Improve your posture while reading or writing. Decrease the chance of back, neck and eye-strain by adjusting the slope angle towards you. No more leaning awkwardly or peering at work across your desk. Made from hardwood with a quality leather writing surface. Loose papers can be held in place by magnets. Pens and books can rest on a rounded ledge.

- ◆ Solid design
- ◆ Non-slip base
- ◆ Folds flat
- ◆ Height-variable
- ◆ Width = 56cm (22.5")
- ◆ Depth = 43cm (17")

The Putnam Writing Slope (PUTWRIT)
£ 56.17 + VAT (**£ 66**)

Posturite Writing Slopes

Large slope (1001)
57cm wide x 44cm deep
£99 + VAT (**£116.32**)



Small slope (1002)
38cm wide x 40cm deep
£89 + VAT (**£104.57**)



Extra magnets (1091)
£3.50 + VAT
(**£4.11**)



Keyboard holder (1041)
57cm wide x 44cm deep
£35 + VAT (**£41.12**)

Book ledger (1031)
£29.50 + VAT
(**£34.66**)



Book holder (1021)
£33 + VAT
(**£38.77**)



Bookstands & document holders



The Bookchair
(BOOCHSTD)
Size = Standard
Weight = 550 grams
Height = 32cm
Width = 24.5cm
Depth = 3cm (closed)

£20 + VAT (**£ 23.50**)

Opens to three angles.
Holds books, paper & laptops.

Small, medium and large sizes also available. Prices vary.



White satin frosted finish

The FlexDoc

(ERGOFLXDC)
Lets you place documents in-line with keyboard and screen and stops you twisting awkwardly to read or write.

£45 + VAT (**£52.88**)



The FlexDoc
Height = 10-16 cm
Width = 39 cm
Depth = 26 cm

Laptop stands



Avoid "laptop hunch" with a sturdy metal laptop stand which easily fits into your briefcase

Slimline ergonomics for people on the move

Winner of a FIRA Ergonomic Excellence Award 2007



The Ergo-Q2 with carry-case
£84 + VAT
(**£98.70**)

Combine the Ergo-Q with a traditional keyboard and mouse, then enjoy the instant benefits of a well set-up ergonomic workstation.

Laptop kits



Kit comprises an Ergo-Q2 laptop stand, Slimline mini-keyboard & cord Unimouse with scroller wheel (ES/Q2KITD)
£104.69 + VAT
(**£123**)



Kit comprises an Ergo-Q2 laptop stand, Slimline mini-keyboard & cordless mouse with scroller wheel (ES/Q2KITDK)
£114.90 + VAT
(**£135**)



Keyboards

Here is a selection of keyboards designed to help people unable to 'get on' with standard issue versions. There are far too many on the market to list here. We also have more in our website shop.



Goldtouch dual connection ergonomic keyboard
(REF: KEYB6D = white)
(REF: KEYB6DB = black)
£139.95 + VAT (**£164.44**)

Goldtouch Dual Connection Ergonomic Keyboard

Goldtouch Keyboards offer a cost-effective and comprehensive method of combating the risk of RSI. The Goldtouch is a split adjustable keyboard with two alphanumeric sections that may be adjusted both horizontally and vertically.

The ergonomic Goldtouch Adjustable Keyboard improves the interface between you and your computer by helping you to assume a more natural posture that improves both comfort and productivity. The Goldtouch has a range of 0° to 30° on both the horizontal and vertical planes, and is continuously variable between these two angles. This means it can be minutely adjusted to allow for individual wrist splay and pronation. Adjustment of the Goldtouch is easily achieved using a locking ball and socket latch mechanism.

Choose the Goldtouch Keyboard if you touch type at 35 words per minute or more. If you type at speeds of more than 70 words per minute, the Goldtouch is absolutely essential to prevent undue stress on the fingers and wrists. The new Goldtouch keyboard uniquely provides both PS2 and USB connection at no extra cost.



Fujitsu-Siemens Ergonomic Keyboard

This ergonomic keyboard offers fatigue free operation by promoting the natural position of the user's arms and hands. This is achieved by angling the two halves of the keyboard at 30 degrees to each other and by additionally incorporating a front-to-back inclination. You can also adjust the horizontal spread to fit exactly with your working position.

If using computers is your living then you should take full advantage of this superb keyboard.

Fujitsu Siemens ergonomic keyboard
(REF: KEYB4)
£82.95 + VAT
(**£ 97.47**)



Microsoft ERGO 4000 Keyboard

- ◆ Depth, external:262mm
- ◆ Interface type:USB
- ◆ Kit contents:Keyboard, software and user guide.
- ◆ Length / Height, external:83mm
- ◆ Width, external:503mm

Microsoft Ergo 4000 keyboard
(REF: KEYB12U)
£32.95 + VAT
(**£ 38.72**)



Microsoft Comfort Curve keyboard

- ◆ Work with your hands in a more natural position
- ◆ Spill-resistant keyboard, withstands accidental drink spill
- ◆ Ultra-thin profile keys
- ◆ Stylish, curved ergonomic design helps wrists and hands rest more naturally for greater comfort.
- ◆ Space-saving design, Multimedia keys.

Microsoft Comfort Curve Keyboard
(REF:CPC 12418)
£25.25 + VAT (**£ 29.67**)



The left-handed keyboard

Just like a right-handed keyboard, except number pad and navigation keys are found on the left.

Left-handed keyboard
(REF:K LH USB)
£89 + VAT (**£104.58**)



BIG Keys keyboard LX
(REF:K 6Y LX)
£99 + VAT (**£ 116.33**)



- ◆ 1" square keys
- ◆ Suitable for early learners, partially sighted and users with limited mobility
- ◆ Lettering **10X** larger than standard
- ◆ F1-F12 function keys
- ◆ QWERTY or ABC layout
- ◆ 10 different models



Slimline Mini-keyboard

- ◆ Elegant black and silver design.
- ◆ Ultrathin style is half the height of traditional keyboards.
- ◆ All keys 'standard' size, including all cursor and PgUp, PgDn keys.
- ◆ Very positive 'scissor action' keys.
- ◆ Eight integrated internet, multimedia and sound keys.
- ◆ Overall Size: 333mm x 175mm. Weight: 545g.

Slimline mini-keyboard
(USB & PS/2)
(REF: KEYBOO1)
£20 + VAT (**£ 23.50**)



Targus Mini Numeric Keypad (USB) with USB Hub.

- ◆ 19-key with 'backspace' and '000' keys for enhanced productivity
- ◆ Unsynchronised 'NumLock' for ease of use.
- ◆ Slim, low profile design for great portability.
- ◆ Built-in 2-port USB hub.
- ◆ USB cable. Plug and Play capability.

Targus Mini USB Number Pad with USB hub
(REF: T/NUMPAD2)
£17 + VAT (**£ 19.97**)

Buy Slimline mini-keyboard and Targus number pad as a kit (Ref: ESKEYKITD) for only £34 + VAT (**£ 39.95**)

Mice

Here is a selection of mice designed to help people unable to 'get on' with standard issue versions. There are far too many on the market to list here. We also have more on sale in our website shop.



Grip Mouse

Grip Mouse has a textured easy grip surface that follows the contours of the human hand. This well made optical mouse features an offset mouse above a sculptured base providing a very comfortable hand position. A very light grip is all that is required to move the mouse around as the base fits so well in the curve of the hand. There are left and right click buttons with a centrally mounted scroll wheel. Choose this mouse for intensive graphics work or if you are experiencing discomfort from your ordinary mouse.

The Grip Mouse
(REF:GRIP)
£42.95 + VAT
(£50.47)



Evoluent Mouse III Supports your hand in a relaxed handshake position, eliminating arm twisting. Left-handed and right-handed versions.

The Evoluent Mouse III has been designed to use with your hand positioned to avoid the twisting of your forearm and allowing a healthier and safer way of working through the day. An ordinary mouse requires your forearm to twist away from its natural position.

The Evoluent Vertical Mice have a patented shape that supports your hand in a relaxed handshake position that eliminates forearm twisting. The mouse remains steady when you press the buttons because the thumb naturally opposes the finger movements.

The Evoluent Mice have five buttons which can be programmed to perform a variety of functions for speeding up common tasks with a single click and reducing repetitive movements.

The Evoluent Mouse
(Right/H) (REF:ERGOMOUS2RL)
£69.95 **(£82.19)**
(Left/H)(REF:ERGOMOUS 2LL)
£79.95 + VAT **(£ 93.94)**

This latest version - the Evoluent Mouse III - offers even higher resolution as a result of its 2600 dpi true optical sensor benefiting users with exceptionally precise tracking. In addition the black and silver Evoluent Mouse III now features a small lip on the bottom edge that prevents the little finger from rubbing the desk.



The Kensington Orbit Elite Mouse

- ◆ A stylish symmetric trackball, easy for finger tip control
- ◆ Designed to assist the natural easy movement of the hand
- ◆ Can be used by right-handed or left-handed people
- ◆ Medium-sized silver ball, operated by finger tips.
- ◆ Two programmable buttons which can be given different functions.
- ◆ This mouse helps reduce the number of clicks you have to make
- ◆ If you already have RSI, the customisable settings of this mouse will help you better manage your injury.

The Kensington Orbit Elite
(REF:JEN563830)
£ 39.95 + VAT
(£ 46.94)



The AirObic Mouse (or The Quill Mouse)

- ◆ Repositions and supports the hand and wrist
- ◆ Minimises pressure on the muscles and tendons
- ◆ Cradles the hand and wrist in an upright position
- ◆ Designed to relieve pressure on the wrist.
- ◆ Available in left or right-handed versions

The Kensington Orbit Elite
(REF: ERGOQUILMAR)
£70 + VAT
(£46.94)



The Ergonomic or Anir Mouse

- ◆ Designed to help avoid or relive RSI
- ◆ Use vertically with hand positioned more naturally
- ◆ Rocker-style thumb-operated mouse button on top
- ◆ This mouse is worked by use of upper arm, which considerably reduces strain on wrist and lower arm

The Ergonomic, Anir or Renaissance Mouse
(REF: ANIR OLB = LARGE)
(REF: ANIR OSB = SMALL)
£70.64 + VAT **(£83)**



Perific Dual Wireless Mouse

- ◆ A new type of pointing device you can use in mid-air
- ◆ You can vary the way you hold it
- ◆ Integrated roller ball.
- ◆ Integrated charger which can charge while the mouse is in use.

The Perific Dual Wireless Mouse
(REF: POS 5381)
£ 69 + VAT **(£ 81)**



Contour Mouse

- ◆ Ergonomic right & left-handed versions.
- ◆ Small, medium, large and extra-large sizes
- ◆ Programmable software included
- ◆ PS2/USB adaptor included

Contour Mouse
Right-hand Small (REF:OSMOCMPRRS)
Right-hand Medium (REF:OSMOCMPCRM)
Right-hand Large (REF:OSMOCMPERRC)
Right-hand Extra-large (REF:OSMOCMPERRXL)
Left-hand Small (REF:OSMOCMPCMTLS)
Left-hand Medium (REF:OSMOCMPERLM)
Left-hand Large (REF:OSMOCMPERLC)
(No Left Hand Extra-large)

Your personal mouse size? Just measure distance from crease of your inside wrist to tip of middle finger:

Less than 17cm = Small; 17-19cm = Medium

19-21cm = Large; over 21cm = Extra-large

All cost £ 75 + VAT **(£ 88.13)**

C.S.ERGONOMICS

17, Alexandria Drive,
St Annes, Lancashire, FY8 1JF.
www.the-comfort-shop.co.uk

(01253) 724902

THE COMFORT SHOP

Wrist rests

Sometimes the simplest products are hard to beat. We've listed our top-selling wrist rests here, but we can obtain many more, just ask.



Mouse wrist rests



Mouse wrist rest
(Ref: TRUMOUSE)
£ 8.22 + VAT
(£9.65)
Size: 26 cm wide
22cm deep



Kensington
height-adjustable
Gel mouse rest
(Ref: JEN 553338)

£15.75 + VAT **(£18.50)**
Dual-height adjustable base
Rubber-non-slip base



Fellowes Premium Gel
mouse wrist rest and pad
with built-in Microban
anti-bacterial protection
(Ref: JEN 267591)
£17.02 + VAT **(£20)**

Smooth graphite pad. Optical mouse
friendly surface. Non-slip base.

Keyboard wrist rests



Keyboard wrist rest
(Ref: TRUWRIST)
£11.62 + VAT
(£13.65)
Size: 51 cm wide
27 cm deep



Kensington height-adjustable Gel
keyboard wrist rest
(Ref: JEN 553303)
£15.75 + VAT **(£18.50)**
Dual-height adjustable base
Rubber non-slip base



Fellowes Premium Gel
keyboard wrist rest and pad
with built-in Microban anti-
bacterial protection
(Ref: JEN 267575)
£22.13 + VAT **(£26)**

Ergorests



Ergorest
(ref: ER-STD)
£59.15 + VAT
(£69.50)
Standard clamp
size: 15-43mm

Ergorest
(ref: ER-LGE)
£ 59.15 + VAT
(£69.50)
LARGE clamp
size: 34-64mm



ER-STD-INT or ER-LRG-INT
£79.15 + VAT **(£93)**

Ergorests
(either size
clamp)
with integral
mouse pad.

★
Height-
adjustable
version
£81.70+VAT
(£96)

Designed to support the arms & shoulders when using a keyboard, thereby reducing the risk of injury. Forearm rest is a soft leather pad. Adjustable arm height is set by a finger screw. Clamps to a desk or workbench.

Wasps



W.A.S.P.
Wrist And Arm Supports,
which help give wrists a
neutral alignment while
using keyboard or mouse
(ref: WASP) per pair
£45.96 + VAT **(£54)**

Wristys



Soft
cushioned
wristbands
to help
support
wrists
while
working

(ref: PUTNWRIS) per pair
£12.77 + VAT **(£15)**
Small for wrists up to 15 cm
in circumference
Medium—up to 17 cm
Large—over 17 cm



Metal Corner Desk Extender

Double the working space at a corner desk with this unique desk extender. When office chair arms jam against the edges of a corner desk and force the user to lean too far forward for

comfort, it is time to use a desk extender. Made of smooth, black powder-coated steel, this desk extender or corner keyboard shelf as they are sometimes known, will make a huge difference to desktop ergonomics, general posture and comfort.

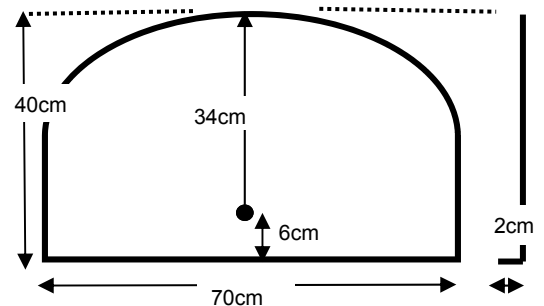

Steel:
Weight: 2.25 Kg
Thickness: 1mm
Colour: black
Finish: Powder-coated

Ref: COMCKS1
£25.00 + VAT
(£29.38)



Before you buy a
costly new desk,
why not ask to
try our Corner
Desk Extender
first....



C.S.ERGONOMICS

17, Alexandria Drive,
St Annes, Lancashire, FY8 1JF.
www.the-comfort-shop.co.uk

(01253) 724902
THE COMFORT SHOP

Backrests

Country seat



Moulded & cushioned back and seat shells. Tartan front and hard-wearing Tufftex fabric on the back

£45.96 + vat
(£54)



Use outdoors as a stand-alone backrest—just link the back and seat with adjustable- straps attached.

Probably one of the best-shaped combined backrest and seat on the market today.

Well-designed, extremely comfortable and robust. Can be used in the car, home, office and outdoors

Weight 2Kg (4.4lb)
Back
height: 48 cm (19")
Width: 33 cm (13")
Seat
Depth: 38 cm (15")
Width: 45 cm (17.5")



Backfriend

Portable combined backrest & seat for car, home and office



Choice of two depths of seat padding



Standard
£50.22 + vat
(£59)



Double-padded
£53.62 + vat
(£63)



Carry case
£14.47 + vat
(£17)



Fleece cover
£27.24 + vat
(£32)

Standard
Weight 1.6 Kg (3.5lb)
Back
Height: 48cm (19")
Width: 29.5 cm (11.5")
Seat
Depth: 36.5 cm (14.5")
Width: 41 cm (16")
Double-padded
Sizes are the same. There is 2 cm (1") extra foam padding on the seat and it is slightly heavier.

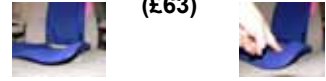

Colours available



Obus Forme backrests



Fabric;
Open weave non-allergenic brushed nylon

Frame;
Bio-mechanically moulded Impact resistant polycarbonate

Core;
Three grades of high resilience urethane foam



Low back
With Velcro-attached height-adjustable lumbar pad.

Height 56 cm (22")
Width; 43 cm (17")
£40.81 + vat
(£47.95)



High back
With Velcro-attached height-adjustable lumbar pad.

Height 79 cm (31")
Width; 43 cm (17")
£49.32 + vat
(£57.95)



Wide back
With Velcro-attached height-adjustable lumbar pad.

Height 53 cm (21")
Width; 51cm (20")
£42.51 + vat
(£49.95)



Custom-air
With built-in inflatable lumbar support.

Height 53 cm (21")
Width; 43 cm (17")
£42.51 + vat
(£49.95)

Seat section

Three section seat, can be joined to any backrest with two Velcro tags



Seat section
With Velcro-attaching tags and zip-off front segment
Depth 46 cm (18")
Width; 43 cm (17")
£32.30 + vat
(£37.95)

Obus Forme Low Back Sport Support



Sporty mesh version of the Low back (shown above)

Low Back Sport Support
REF: EZLLBSS
£42.51 + vat
(£ 49.95)

- ◆ The same support and comfort as the
- ◆ OBUSFORME® Lowback Support
- ◆ Sporty black and grey design
- ◆ Includes adjustable/removable lumbar pad
- ◆ Dimensions 21" x 17"



The MedAir, a new inflatable portable backrest, which works on most office chairs and rest room chairs; in motor vehicles and chairs at home.

- ◆ Portable
- ◆ Inflatable
- ◆ Adjustable
- ◆ Fixing-straps
- ◆ Works on office chairs, home chairs, meeting chairs and in the car.
- ◆ Breathable fabric cover

The MedAir inflatable backrest
£ 63.83 + VAT (£ 75)

Posturecurves

Still our top-selling model of one-piece portable backrest



BUY THESE from our [ONLINE SHOP](#)

Posturecurve Comfy
£29.79 + vat
(£35)

The Comfy is about 30% softer than the Traditional

Posturecurve Traditional
£29.79 + vat
(£35)

A Traditional offers firm support to heavier users

Posturecurve Visco 'memory'
£35.75 + vat
(£42)

A new 'memory' foam version. Useful if back is very tender

Superests

A unique shape, designed over 25 years ago by James Putnam



Superest Traditional
£39.15 + vat
(£46)

The Superest has prominently-shaped sides panels which curve around the lower back and kidneys. People who dislike sudden lateral movements (in a car or on soft furniture) tend to like the 'snug' support a Superest provides.



Both models have an adjustable elastic fixing strap

Superest Visco 'memory'
£45.96 + vat
(£54)



A new 'memory' foam version. Useful if back is very tender

Wedges

If sitting **hunched up** in the office, car or home, a seat wedge could you sit more **correctly**.



- Cut-out at the back to relieve pressure on the coccyx.
- Handy carrying strap attached
- Two-year guarantee. Allergy tested.

DIMENSIONS:
Height: (back) 5 cm
Width:- 43 cm
Depth:- 40 cm

Colours: Blue or Grey

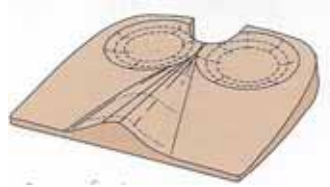

Sissel Coccyx Contour Wedge
£27.19 + VAT (£31.95)

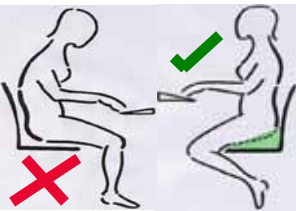

DIMENSIONS: 11-degree
Height (at back):- 9.5 cm
Width:- 36 cm
Depth (of slope):- 36 cm



11-degree wedge
Solid or with coccyx cut-out
£ 29.02 + VAT
(£34.10)

DIMENSIONS: 8-degree
Height (at back):- 8 cm
Width:- 36 cm
Depth (of slope):- 36 cm



8-degree wedge
Solid or with coccyx cut-out
£ 24.26 + VAT
(£28.50)

Putnam Wedge
£38.72 + VAT
(£45.50)

DIMENSIONS: The Wedge
Height (at back):- 15 cm
Width:- 40 cm
Depth (of slope):- 41 cm



Putnam Super Wedge
with VISCO 'memory' top layer
£46.81 + VAT (£55)



DIMENSIONS: Super Wedge
Height (at back):- 15 cm
Width:- 40 cm
Depth (of slope):- 41 cm

Lumbar rolls



McKenzie 4" roll
£ 14.47 + VAT
(£ 17)



Circular lumbar rolls work best on soft furniture. The softer the furniture, the bigger the roll

McKenzie 5" D- roll
£ 14.47 + VAT
(£ 17)



D-rolls and Super-rolls work best on firm furniture and in cars



McKenzie 5" roll
£ 14.47 + VAT
(£ 17)



McKenzie Super roll (oval X-section)
£ 24.50 + VAT
(£ 28.79)



C.S.ERGONOMICS

17, Alexandria Drive,
St Annes, Lancashire, FY8 1JF.
www.the-comfort-shop.co.uk

(01253) 724902
THE COMFORT SHOP

The Hip Seat

An excellent way of protecting your back when carrying a baby or young child. A 'must-have' for busy parents.



Hipseat is a back supporting belt designed to reduce the strain on an adult's back when carrying babies and young children aged six months to 3 years.

Endorsed by osteopaths, chiropractors and physiotherapists.

A Hipseat redistributes the weight of the child away from the upper back, shoulders and arms, spreading it evenly around the waist. The Hipseat fastens with Velcro and has an extra safety strap with quick-release clip. It makes a very good alternative to child carriers which require the weight to be borne on the back, front or over the shoulder. Priced at £29.75 + VAT (**£34.95**)



Black



Burgundy



Dark Blue



Olive green

Chair mats

CLEARTEX Polycarbonate Floor Mats

- ◆ Fire resistant and extremely durable
- ◆ Virtually unbreakable
- ◆ Odourless & free of toxic chemicals
- ◆ Anti-static
- ◆ Environmentally safe. 100% recyclable
- ◆ Easy-clean with soap and water



Rectangular



Triangular

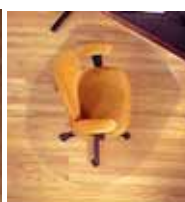

Rounded



Rectangular (+ lip)

BUY these from our [ONLINE SHOP](#)

Kneeler stools



Steel frame (height-adjustable)



Putnams Kneeler with coccyx recession

Putnams Kneeler with flat seat



The Karonorm Kneeler

YES! We supply kneeler stools. But, these days, for every customer who bought a kneeler, about 200 others preferred an office chair with a tilting seat.

BUY THESE from our [ONLINE SHOP](#)

Posture Minder



Award-winning intelligent posture reminder software. Postureminder continually checks your working position and reminds you with occasional on-screen pop-up messages to stop slouching or take a short break! It can even tell you when your bad sitting habits start to improve as days go by! User-friendly and effective.

Musculoskeletal disorders (MSDs) cost UK industry 18 million lost working days and more than £5.7bn each year. The average cost of absences per employee is estimated by the Health & Safety Executive at up to £1,600 per employee.

Postureminder is a software tool which can be easily and quickly installed on laptops and desktop CPUs. Then, with the aid of a webcam, it will monitor your working position and occasionally give you a friendly on-screen reminder when your posture is 'slipping'! It can remind you to take a short break, when to have a quick stretch or even when to Postureminder has been designed to protect your health. It doesn't watch you like a hawk!

Postureminder Packages start at £ 25.52 + VAT (**£ 29.99**)

BUY THESE from our [ONLINE SHOP](#)



Helpful for all the family, schools, colleges and business users.

C.S.ERGONOMICS

17, Alexandria Drive,
St Annes, Lancashire, FY8 1JF.
www.the-comfort-shop.co.uk

(01253) 724902

THE COMFORT SHOP

Terms and Conditions of Business

1] Conditions.

1.1 These Conditions form the basis of the contract between the Seller and the Buyer in relation to the sale of Goods, to the exclusion of all other terms and conditions, including the Buyer's standard conditions of purchase or any other conditions which the buyer may purport to apply under any purchase order or confirmation of order by any other document.

1.2 Acceptance of our sales order acknowledgement or delivery of the Goods shall be deemed to be conclusive evidence of the Buyer's acceptance of these conditions.

2] Changes to, re-sourcing of and substituting goods.

2.1 Our suppliers often reserve the right to make small design changes to their products We have no control over this. We will tell you of any major changes which may affect product performance. If we can no longer obtain the exact goods featured in our brochure, but can re-source an almost identical alternative; we will advise you whenever possible if the alternative is fundamentally different in design.

3] Prices.

3.1 Our price shall be the price quoted on the Seller's confirmation of order. The Buyer may request a confirmation of order from the Seller. Prices exclude VAT, which shall be due at the rate in force on the date of the Seller's invoice. We will try and hold to, or quote from the prices listed in our catalogue. But we reserve the right to: a) quote more contemporary prices than those in the catalogue, or; b) increase any price prior to shipment, if caused by a major change in the currency exchange rate or increase in manufacturing costs.

3.2 Additional postage, freight, delivery, assembly and set-up charges will be made by prior agreement between Buyer & Seller.

4] Cancellations.

4.1 Many of our Goods are specially made-to order or imported-to-order; for this reason, the Buyer must take special care when cancelling or amending an order for goods. Failure to provide us with a written cancellation of the order before the goods are specially made or arrive from abroad, will leave the Buyer still liable to pay for the goods, or at least liable to a 25% surcharge if we are able to disassemble the Goods and return them to stock.

4.2 We wish to avoid delivering such goods, only to find the end-user no longer needs them for any reason (for instance, they may no longer work for the Employer/ Buyer who ordered the goods) and the Employer / Buyer has neglected to inform us well in advance of this change in circumstances.

4.3 The Buyer may cancel an order of goods excluding the type described in 4.1 by sending a written request to the Seller at any time up to receipt of the goods and within 7 working days thereafter, beginning with the day after the day the Buyer received the goods.

4.4 If the Buyer wishes to return unsuitable Goods, the Buyer must return the Goods carriage paid, in perfect condition, in their original intact packaging, with appropriate paperwork. If the Buyer fails to return the goods within a reasonable time, they will be liable for the cost of collection. We do not refund the original outward carriage costs.

5] Delivery.

5.1 The Seller will do everything possible to despatch the Goods within 4-6 weeks of receipt of order, or on an agreed delivery date, but does not guarantee to do so, as the Seller is subject to the usual types of national and international freight hold-ups and manufacturing delays etc.

5.2 The Seller shall not be liable to any loss or damage whether arising directly or indirectly from the late delivery or short delivery of goods. If short delivery does take place, the Buyer undertakes not to reject the Goods, but to accept the Goods delivered as part performance of the contract.

5.3 If the Seller has arranged a specific time & date to deliver and demonstrate Goods to an end user, but the end-user is not there at the time of delivery, additional charges will be made to cover storage and re-delivery on another date.

6] Claims for damaged goods.

6.1 Visible transport damage and short deliveries must always be noted on the delivery note paperwork retained by our driver and the copy retained by the recipient. Damage to deliveries via Post Office or Carrier must be reported to the Seller within three working days.

6.2 The Buyer shall be deemed to have accepted the Goods 36 hours after delivery.

6.3 The Buyer shall carry out a thorough inspection of the Goods within 36 hours of delivery and shall give written notification to the Seller within 5 working days of delivery if the Goods have any defects which a reasonable examination would have revealed.

7] Title, Risk & Returns.

7.1 The Goods are the risk of the Buyer from time of delivery.

7.2 The Buyer does not own the Goods until they are paid for in full, including any additional interest and costs sought in compensation for late payment.

7.3 All transactions on a sale-or-return basis must be agreed in advance between the Buyer and the Seller.

8] Warranties.

8.1 The Seller will honour the various warranties offered by manufacturers and suppliers of Goods sold to the Buyer.

9] Payment terms.

9.1 **Account customers:** Payment of the Price and VAT shall be due within 20 days of the date of the Seller's invoice. We reserve the right to charge interest on overdue invoices. Interest shall accrue from the date when payment becomes due, calculated on a daily basis until the date of payment. Such interest shall accrue after as well as before any judgement.

9.2 **Pro-forma customers:** Goods will not be made-to-order or imported unless paid for in advance by non-account holders.

9.3 **Cash on delivery (cash or card).** Such payments must be actual cash or by credit card. Cheques will only be accepted at the Seller's discretion.

Card Payments.

10.1 We accept most credit cards and some corporate purchasing cards. Buyers intending to pay by corporate purchasing card must advise us of their intention at the time of ordering.

10.2 We reserve the right to refuse payment by card and insist on payment by cheque or BACS if we do not have a prior arrangement for particular customer to pay by card.

Ordering made easy

**Call the Comfort Shop
Sales and Advice lines:**
(01253) 724902 / 726483
Open from 9-5 Mon to Sat.

Or email us at:
stannes@the-comfort-shop.co.uk

Order Fax Lines:
(01253) 724902 / 726483

Order by Post to:
The Comfort Shop Ltd.
(C.S. Ergonomics)
17 Alexandria Drive,
St Annes, Lancashire FY8 1JF

Ordering via the internet:
www.the-comfort-shop.co.uk

Our website features the best-selling smaller, back and neck-care products. For larger items such as chairs, desks and ergonomic accessories, customers tend to ring us first, then order by fax or 'phone.

Use our **personal door-to-door delivery** service, for the 'greater' north-west. This end-user delivery and demonstration service, provided by our own staff, costs:
£20 + VAT for an office chair, desk or accessories.
Door-to-door prices will vary according to the distance we must travel.

We use **carriers** when customers are outside the north-west and are content to un-box their own chair and teach themselves how to use it. They are always welcome to ring us for some tips.

Our **Post & Packing** service for customers on the U.K. mainland costs:
£ 7.50 + VAT for orders up to £100 in value
£ 12.50 + VAT for orders over £100 in value (chairs and desks are extra).

Remember, the Buyer pays to send returned goods back to us. We do not refund the original outward carriage costs.
(see our terms & conditions).

Photocopy this order form, fill in details of the goods you need, then fax it or post it to us at The Comfort Shop Ltd. (C.S. Ergonomics).

Your Official Order Number
(if appropriate):
.....

Please send me:

Product Code	Description	Colour, Size, etc.	£ Unit Price	Quantity	Total Price

Delivery Address:

Name:

Address:

.....

.....

.....

.....Post Code:.....

Daytime Phone:

Fax:

Invoice Address:

Own Name / Company Name:

Address:

.....

.....

.....Post Code:.....

.....Daytime Phone:.....

Fax:

Carriage Costs

Sub-total excluding VAT

VAT. (Currently) 17.5%

TOTAL DUE

Send To:

The Comfort Shop Ltd.
(C.S. Ergonomics)
17 Alexandria Drive,
St Annes, Lancashire FY8 1JF

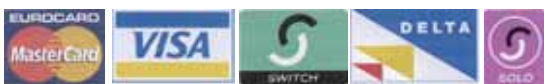

I wish to pay by Visa / Eurocard MasterCard / Switch / Delta / Solo / Any Other? Cheque (delete the rest).

I authorise you to debit my account with the amount of £.....

My card number is:

Issue Number (Maestro & Solo cards if applicable) Expiry date of card

Card security code (last three digits on back of card)

Name (exactly as on card).....
& Address.....
.....
.....Post Code.....

Signature.....
Date.....
Telephone number (inc. prefix)
.....

C.S. ERGONOMICS



Website: www.the-comfort-shop.co.uk
Email: stannes@the-comfort-shop.co.uk

Our Story:

The Comfort Shop opened in January 1989. We set out to provide a selection of well-designed, helpful, supportive furniture and associated products for people with special comfort requirements. Nowadays the company has two divisions:

C.S. Ergonomics, for office and workplace back-care and comfort, and

Back-Care, for high-seat, back-care and electrical furniture for home.

Our Aim:

Is to be as helpful as we can.

Choosing the right products to enable you to work and live comfortably and effectively can be a big decision. It is important to get it right and our job is to make that happen.

If at first we don't succeed, we will try another solution.

"We won't relax 'til our customers can" is our company motto after all.

Our Strengths:

We are a flexible firm, geared to respond swiftly to your needs. We offer on-site product demonstrations and like to deliver our goods personally, whenever possible, giving users a product lesson in their workplace or home. If the need arises, we can ask trained ergonomists, occupational therapists or physiotherapists to help us solve tricky comfort problems. We also have a 'try before you buy' service for some products, if customers need a little more time to decide.

Our Wish:

Is to have satisfied customers. So how can we help you?

"We won't relax 'til our customers can"

C.S. ERGONOMICS

THE COMFORT SHOP

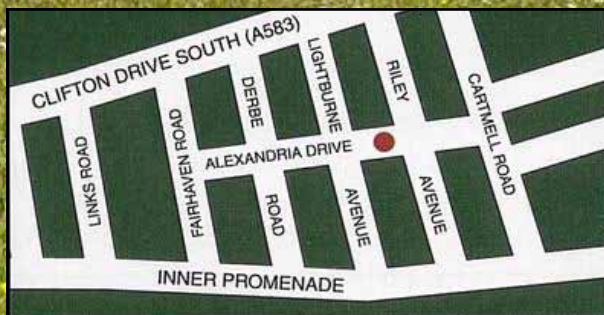

**17 Alexandria Drive,
St Annes
Lancashire, FY8 1JF
Phone: (01253) 724902
Fax: (01253) 724902**